

**GREENCLEAN
AUTO WASH
5TH STREET**

TAX MAP: #21-B-44
 ZONING: HW
 SITE AREA: 0.901 ACRES (39,247 SF)
 CURRENT USE: BANK
 PROPOSED USE: CARWASH
 BUILDING LENGTH: 100 FT
 BUILDING AREA: 3000 SF
 VACUUM SPACES: 20
 EMPLOYEE PARKING SPACES: 3
 STACKING REQUIRED: 240 FT
 STACKING PROVIDED: 300 FT+

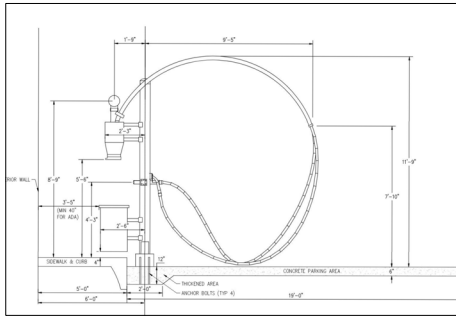

TYPICAL VACUUM DETAIL

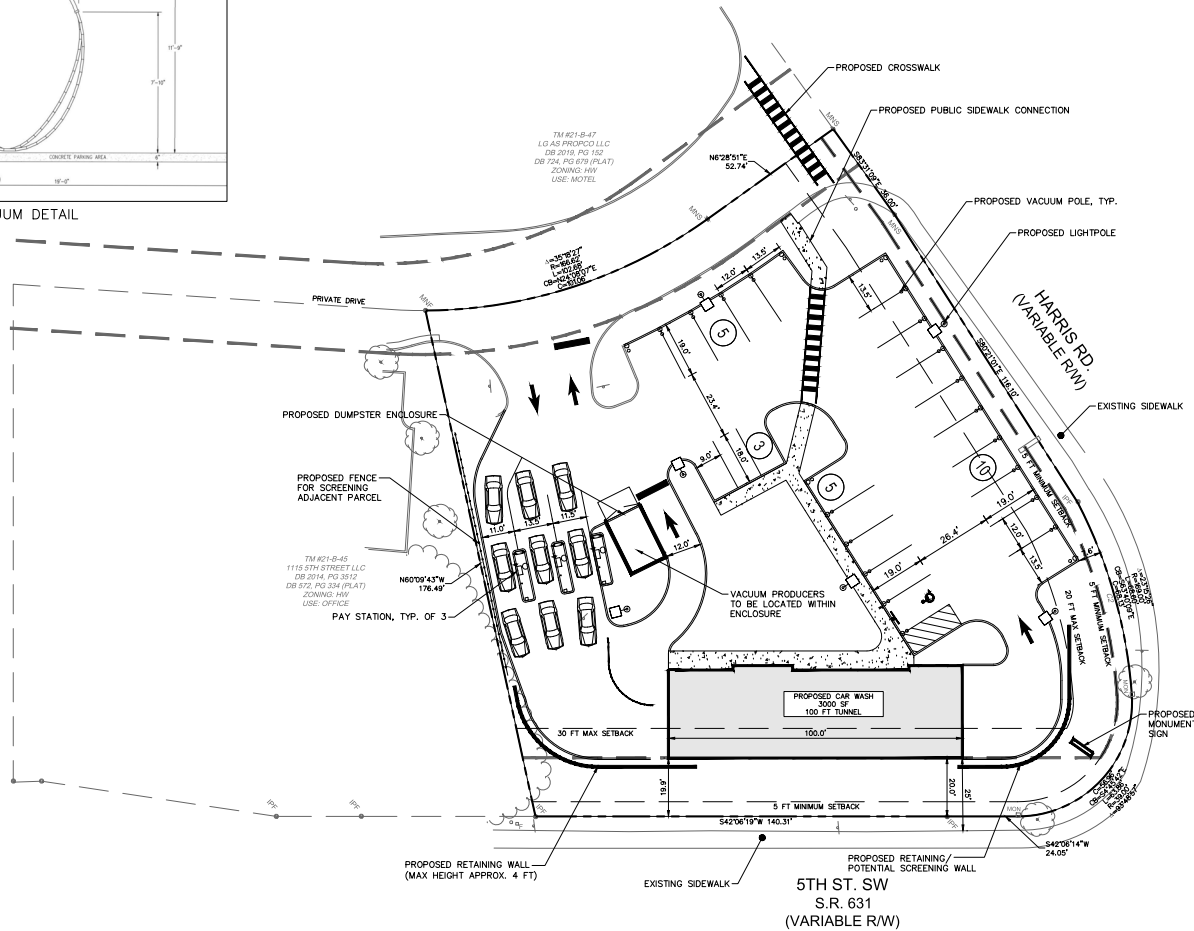

LIGHTING NOTE:
 ALL LIGHTING SHALL BE IN CONFORMANCE WITH THE REGULATIONS SET FORTH IN SECTIONS 34-1000, ET SEQ.



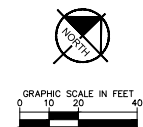

LAYOUT PLAN

DATE: 10.10.22



Kimley»Horn

CONCEPT PLANT SCHEDULE

	LARGE DECIDUOUS TREES 250 SF CANOPY/EA	11	Acer rubrum 'October Glory' TM / October Glory Maple Liquidambar styraciflua / Fruticose Sweet Gum Platanus x acerifolia 'Boothooood' / London Plane Tree Quercus phellos 'Hightower' / Willow Oak B & B, 2.5' Cal B & B, 2.5' Cal B & B, 2.5' Cal B & B, 2.5' Cal
	ORNAMENTAL TREES	5	Cercis canadensis 'Hearts of Gold' / Hearts of Gold Redbud Cornus x 'Rutican' TM / Constellation Flowering Dogwood Prunus x yedoensis 'Yoshino Cherry' B & B, 8' HT. MIN B & B, 8' HT. MIN B & B, 8' HT. MIN
	EVERGREEN TREES	15	Ilex opaca 'Jersey Knight' / Jersey Knight American Holly Ilex x 'Nellie R. Stevens' / Nellie R. Stevens Holly B & B, 8' HT. MIN B & B, 8' HT. MIN
	SHRUBS	87	Abelia x 'Rose Creek' / Rose Creek Abelia Ilex cornuta 'Burfordii Nana' / Dwarf Burford Holly Ilex glabra 'Shamrock' / Shamrock Inkberry Holly Cont., 36" HT. MIN. Cont., 36" HT. MIN. Cont., 36" HT. MIN.

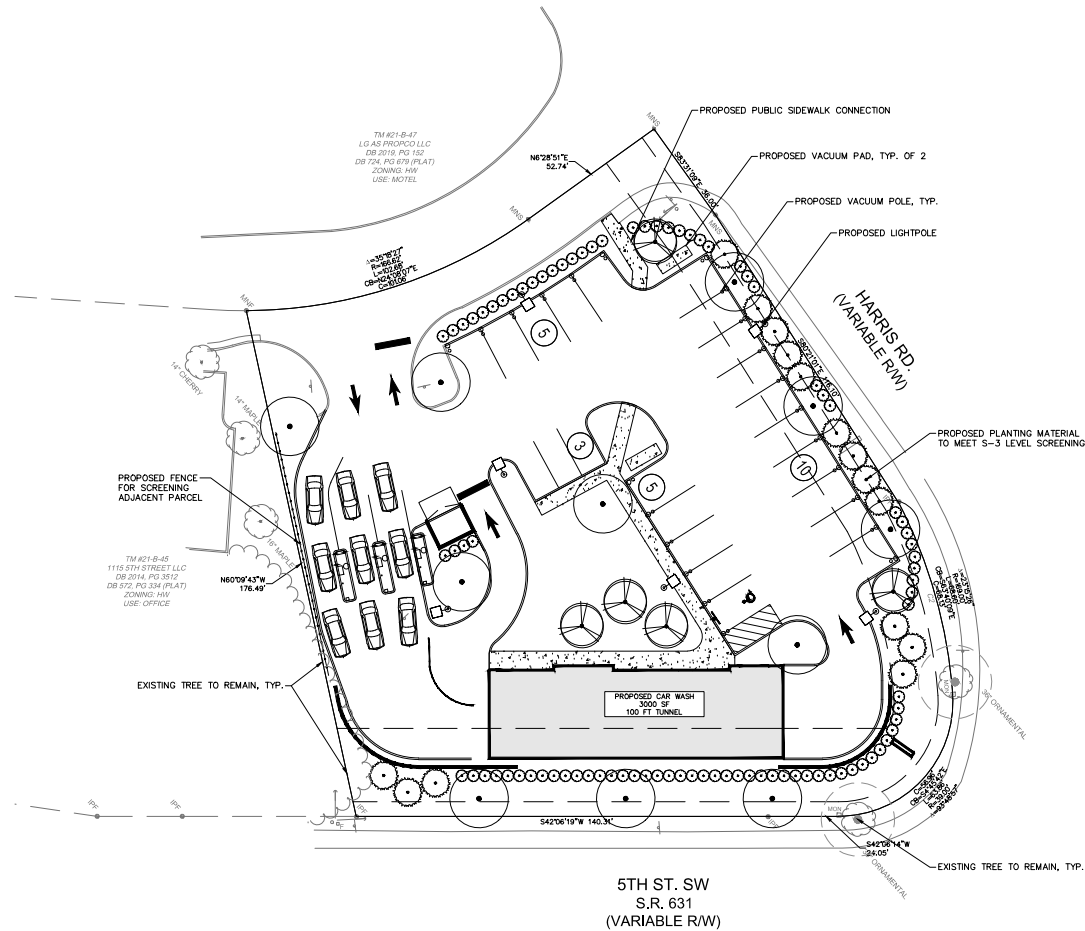

GREENCLEAN
AUTO WASH
5TH STREET

LANDSCAPE PLAN

DATE: 8.16.22

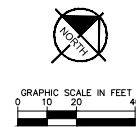

Kimley»Horn