



CITY COUNCIL AGENDA March 20, 2023

J. Lloyd Snook, III, Mayor
Juandiego Wade, Vice Mayor
Michael K. Payne, Councilor
Brian R. Pinkston, Councilor
Leah Puryear, Councilor
Kyna Thomas, Clerk

4:00 PM OPENING SESSION

Register at www.charlottesville.gov/zoom. The public may view this portion of the meeting electronically by registering in advance for the Zoom webinar or on the City's streaming platforms and local government Channel 10. Individuals with disabilities who require assistance or special arrangements to participate in the public meeting may call (434) 970-3182 or submit a request via email to ada@charlottesville.gov. The City of Charlottesville requests that you provide a 48-hour notice so that proper arrangements may be made.

Call to Order/Roll Call

Agenda Approval

Reports

1. Presentation: Decarbonization Study Kickoff
2. Report: Charlottesville Redevelopment and Housing Authority update on sustainability and status with the Department of Housing and Urban Development

5:30 PM CLOSED SESSION pursuant to Sections 2.2-3711 and 2.2-3712 of the Virginia Code (Boards and Commissions)

6:30 PM BUSINESS SESSION

This portion of the meeting will accommodate a limited number of in-person public participants in City Council Chamber at City Hall as we employ a hybrid approach to public meetings. Registration is available for a lottery-based seating selection at www.charlottesville.gov/1543/Reserve-a-Seat-for-City-Council-Meeting. Reservation requests may also be made by contacting the Clerk of Council office at clerk@charlottesville.gov or 434-970-3113.

Moment of Silence

Announcements

Recognitions/Proclamations

- Proclamation: Women's History Month

Board/Commission Appointments

Consent Agenda*

3. Minutes: February 21 regular meeting; March 6 regular meeting, March 9 Budget Work Session
4. Resolution: Settlement for Opioid Related Claims (2nd reading)

City Manager Report

Community Matters

Public comment for up to 16 speakers (limit 3 minutes per speaker). Preregistration available for first 8 spaces at <https://www.charlottesville.gov/692/Request-to-Speak>; speakers announced by Noon on meeting day (9:00 a.m. sign-up deadline). Additional public comment at end of meeting.

Action Items

5. Appeal: Appeal of BAR (Board of Architectural Review) denial of Certificate of Appropriateness: First United Methodist Church solar panel project
6. Public Hearing: Proposed real estate tax rate for the FY 2024 City Manager's Proposed Budget

7. Public Hearing/Res.: Approving Lease Agreement with Albemarle Charlottesville Historical Society for lease of 200 Second Street NE (1 reading)
8. Resolution: Appropriating funding from the Virginia Land Conservation Fund for Moores Creek Parkland Acquisition - \$175,000 (1 of 2 readings)
9. Resolution: Appropriating funding from the Land and Water Conservation Fund for Moores Creek Parkland Acquisition - \$175,000 (1 of 2 readings)

General Business

10. Written Report: Land Use and Environmental Planning Committee Semi-Annual Report (written report only)

Other Business

Community Matters (2)

Adjournment

**CITY OF CHARLOTTESVILLE, VIRGINIA
CITY COUNCIL AGENDA**



Agenda Date:	March 20, 2023
Action Required:	No Council Action Required
Presenter:	Lauren Hildebrand, Director of Utilities
Staff Contacts:	Lauren Hildebrand, Director of Utilities
Title:	Decarbonization Study Kickoff

Background

The City of Charlottesville's natural gas utility is one of three municipally owned gas utilities in the Commonwealth of Virginia. The City of Charlottesville has provided reliable natural gas to the residents and businesses of Charlottesville and Albemarle County, including the University of Virginia, for over 150 years. Currently, the City operates and maintains a natural gas distribution system comprised of 340 miles of natural gas main lines and serves over 21,500 customers.

The City of Charlottesville, Albemarle County and other local municipalities have made commitments to community-wide greenhouse gas emissions reduction goals. On July 1, 2019, City Council adopted the goal of a 45% reduction in community-wide greenhouse gas emissions by 2030 and a goal of carbon neutrality by 2050. Both of these reduction measures will be based on the 2011 inventory year. Albemarle County has made the same level of emissions reduction commitments, measured from its 2008 inventory year.

As a result of the City of Charlottesville owning, operating and maintaining a natural gas utility, the utility's role and responsibilities regarding community-wide greenhouse gas reductions must be thoroughly evaluated. The Department of Utilities has solicited the expertise of an outside consulting firm in order to responsibly and accurately determine how the gas utility can be a part of the solution in achieving and aligning itself with the community's greenhouse gas reduction goals.

Discussion

The Study will determine the legality, under federal, state and local laws, of potentially discontinuing the natural gas system, and/or discontinuing future residential, commercial, industrial connections to the gas system. If one or both of these scenarios are determined to be legal, the impact to existing and future customers and the City of Charlottesville will be evaluated. The Study will also model various scenarios in which our gas utility can achieve or exceed the greenhouse gas emissions reduction goals. The modeling will evaluate cost impacts and resiliency implications to customers by looking at technology and energy efficiency improvements in order to reduce greenhouse gas emissions. In addition, the study will evaluate and make recommendations to improve the Charlottesville Gas Energy Efficiency Program and the operations and maintenance of the natural gas system. The City anticipates the project to take approximately one year to complete.

Alignment with City Council's Vision and Strategic Plan

This Project contributes to Goal 3 of the Strategic Plan: A Beautiful and Sustainable Natural and Built Environment.

Community Engagement

The Department of Utilities and the consultant will gather input from stakeholders in the community and update Council and the community on the results of the study.

Budgetary Impact

The Study will be paid from natural gas enterprise operating funds.

Recommendation

There are no staff recommendations and the presentation is intended to update City Council on the Study.

Alternatives

Attachments

1. BV Presentation 3-20-23

City of Charlottesville – Decarbonization Study

Dr. Hua Fang

Managing Director – Global Advisory

Today's Discussion

- Introduction to Black & Veatch
- Decarbonization Study – Goals and Objectives
- Study Scope of Work and Timeline
- Questions/Answers

Black & Veatch Today

- 9,200+ professionals in 120+ offices
- Headquarters in Overland Park, Kansas, USA
- Employee Stock Ownership Plan structure
- Projects in 100+ countries on six continents
- \$4.0 billion in 2022 revenue
- Sectors
 - Commercial; Governments; Industrial & Manufacturing; Mining; Gas, Fuels, & Chemicals; Power; Telecommunications; Transportation; Water

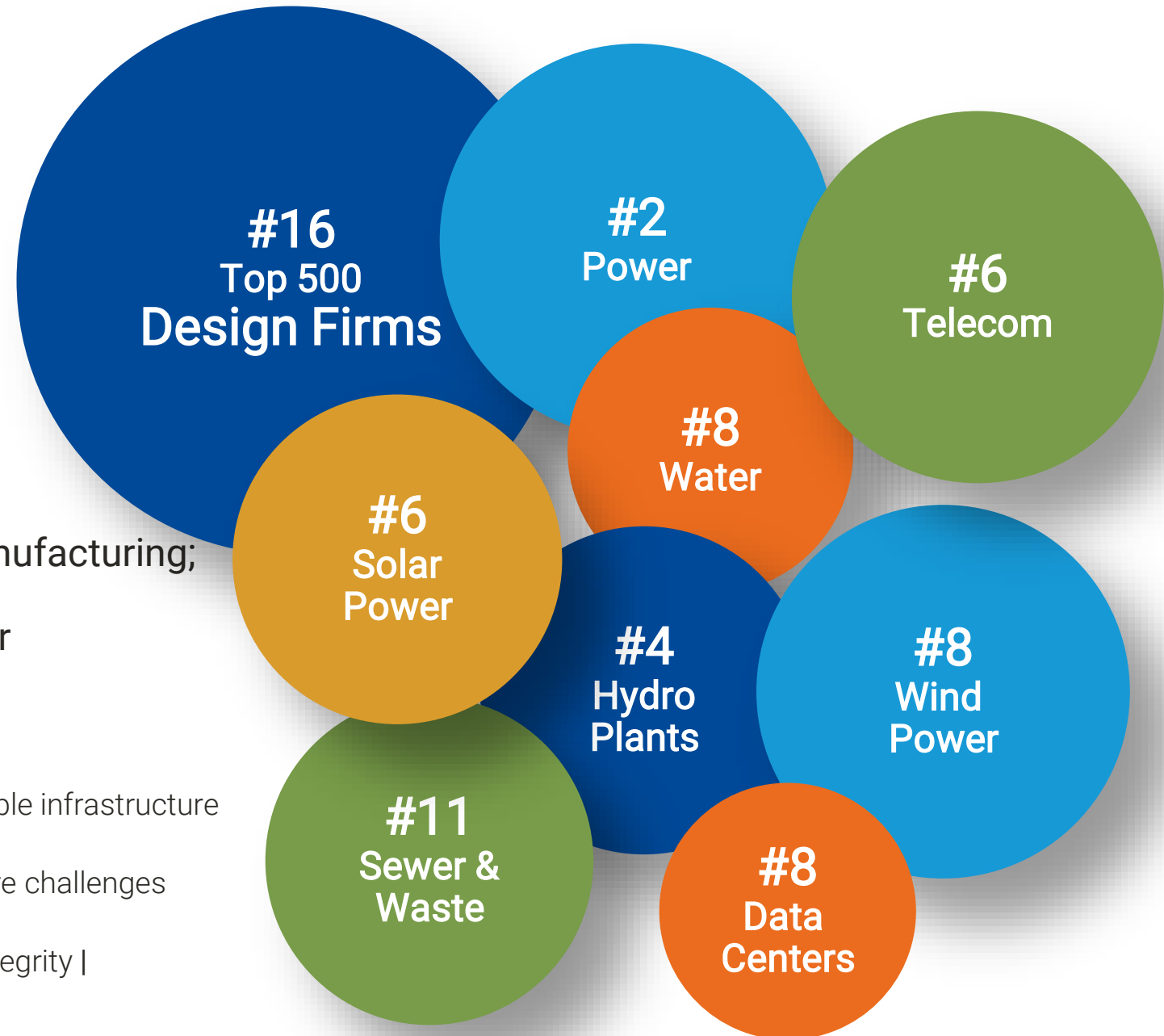

Mission: *Why we exist*

Building a world of difference through innovation in sustainable infrastructure

Vision: *What future we aspire to achieve*

We work relentlessly to solve humanity's critical infrastructure challenges

Values: *What we believe and how we behave*

Safety | Accountability | Collaboration | Entrepreneurship | Integrity | Ownership | Respect

Current Engineering News-Record rankings.

Strategic Advisory

Key Business Areas and Primary Solution Offerings



Strategy & Planning

- Decarbonization Strategic Planning
- Integrated Resource Planning
- Clean Power Procurement
- Transmission Strategy and Planning
- LNG and Other Fuels Strategic Planning
- Hydrogen Fuels Strategic Planning
- Transportation Electrification Strategic Planning
- Grid Mod, DER Integration Strategic Planning
- Program Management (PMO)



Rates & Regulatory

- Financial modeling and rate design for public power entities
- FERC and State Regulatory Support
- Performance-Based and Infrastructure Ratemaking
- Alternative Regulation Services
- Financial Planning, Cost of Service, and Bond Feasibility Studies
- Stormwater Utility Development and Implementation Support
- Business Operations Reviews

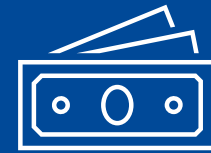

Transaction Services

- Independent Engineering / Technical Due Diligence
- Restructuring Advisory Support
- Construction and Operations Monitoring
- Project Development and Valuations
- Electricity and Fuel Price Forecasting

Black & Veatch Strategy & Planning – Decarbonization Study

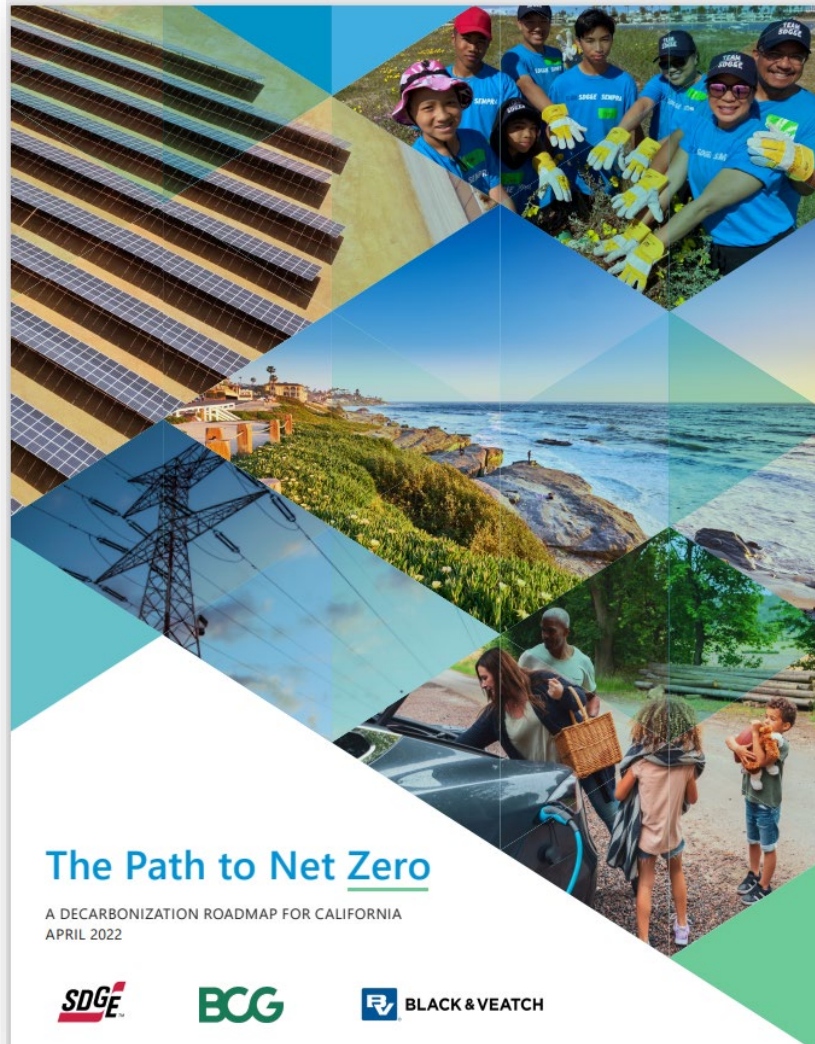

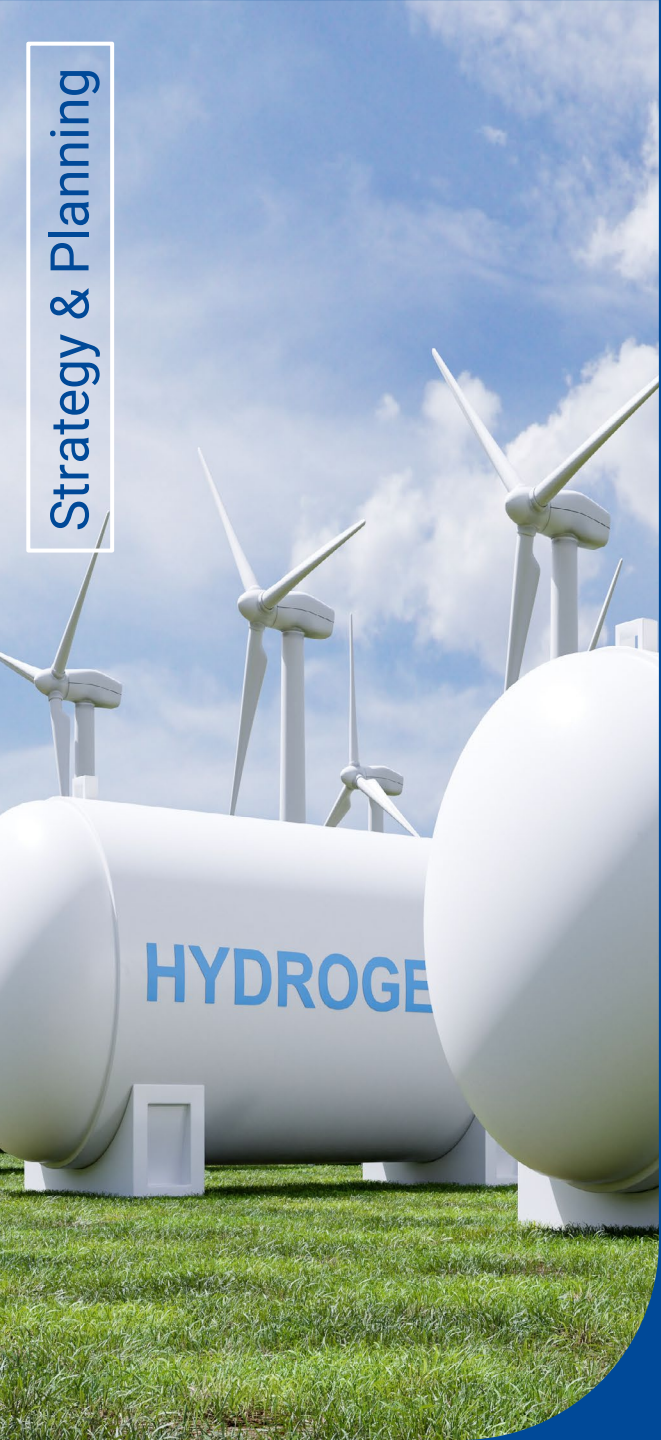

Hydrogen Hub Prefeasibility Study

Hydrogen Hub Developer

Client Need

- A prefeasibility assessment and high-level cost estimate for a hydrogen hub capable of producing a large amount of hydrogen from electrolysis using renewable energy resources and guidance on energy requirements and energy production profile assessment to achieve a sustainable capacity factor of the hydrogen production facility.

Value Delivered

- A successfully designed hydrogen hub that optimizes energy sources, hydrogen production, storage, and transportation technologies.

Hydrogen Blending Strategy and Assessment

Mid-West Gas Utility

Client Need

- Achieving a hydrogen blending goal as part of its decarbonization plan and needed guidance on engineering, operational and other system requirements for blending hydrogen into its system and implementation strategies to reach the blending objective.

Value Delivered

- Assisted Client in identifying the most appropriate strategies to achieve blending goals.
- Helped Client reach the second phase towards successful blending operation.

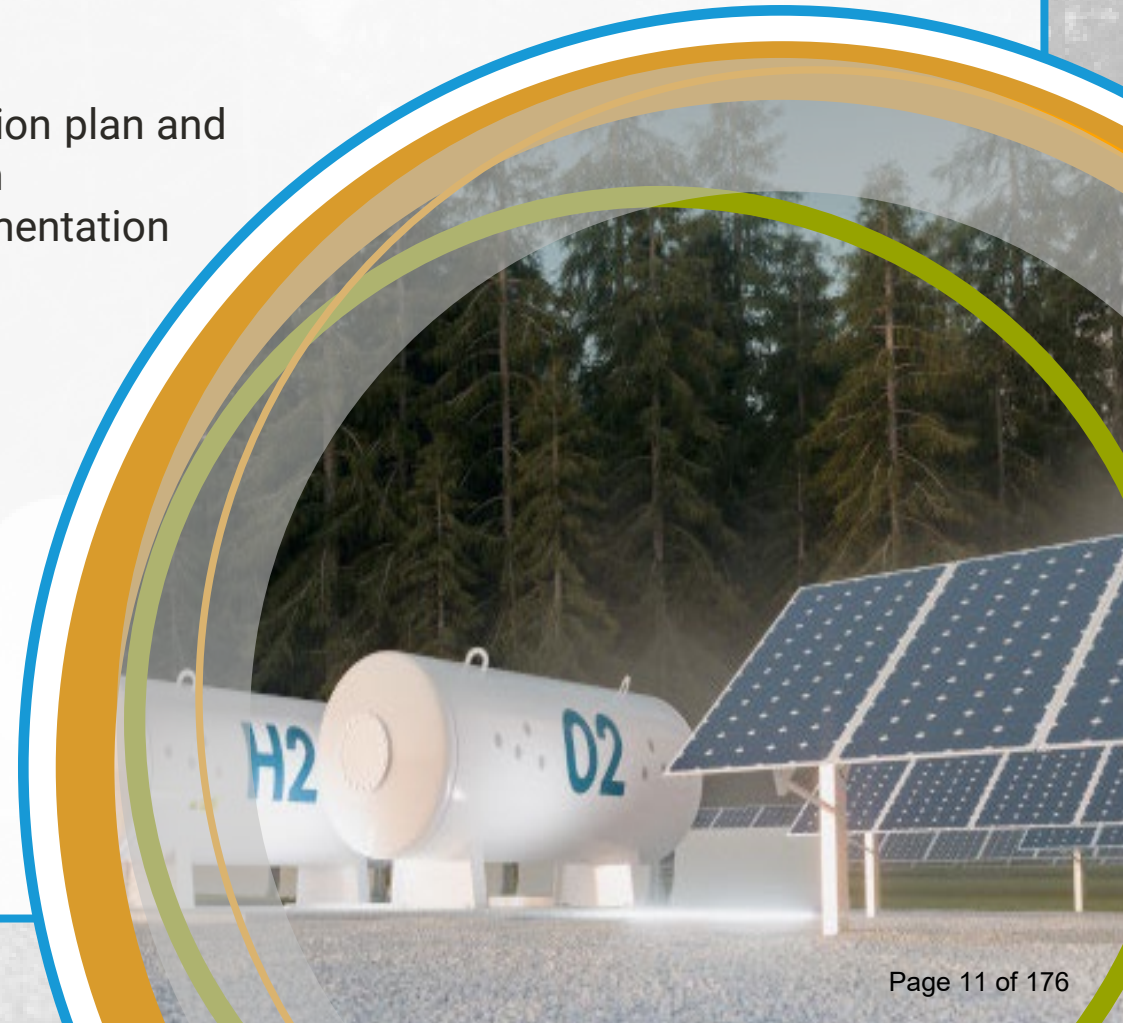

Fleet Electrification Strategy

Entergy

Client Need

- Prepare for and evaluate the business opportunities associated with fleet electrification within their service territory and to understand their role in building and providing infrastructure to those fleets.

Value Delivered

- Provided a robust business case and strategy for entering the fleet electrification market that best positioned Entergy for immediate and long-term success. Included customer segmentation, market assessment, risk assessment, utility revenue requirements, and competitive analysis to guide their decisions around establishing the business.



Today's Discussion

- Introduction to Black & Veatch
- Decarbonization Study –Goals and Objectives
- Scope of Work and Timeline
- Questions/Answers

Decarbonization Study – Goals and Objectives

Charlottesville GHG Emissions
(Total by Year)

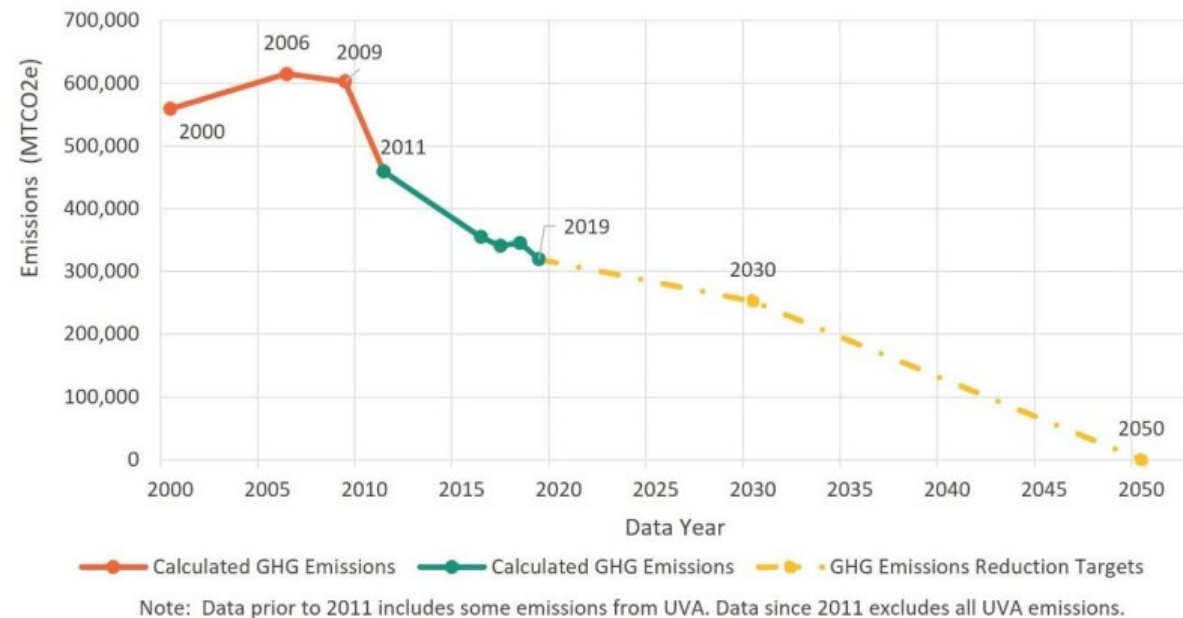

City of Charlottesville Goal:

- A 45% reduction in community-wide greenhouse gas emissions by 2030 based on the 2011 inventory year
- Carbon neutrality by 2050

Study Objective:

- Identify and evaluate potential solutions for the gas utility to align with the community's greenhouse gas reduction goals

Today's Discussion

- Introduction to Black & Veatch
- Decarbonization Study –Goals and Objectives
- **Scope of Work and Timeline**
- Questions/Answers

Project Scope and Timeline

- **Legality**
 - Support legal review of discontinuing natural gas distribution operations and new connections
- **Utility System Modeling and Evaluation of Different Pathways**
 - Energy Efficiency
 - Electrification
 - Carbon Offsets
 - Renewable natural gas (RNG)
 - Certified natural gas
 - Hydrogen
- **Financial Impact on Customers (Equity Impact)**
- **Evaluate Gas Utility Operations and Energy Efficiency Programs and propose recommendations**
- **Timeline 1 year to complete**

Study Focus and Approach

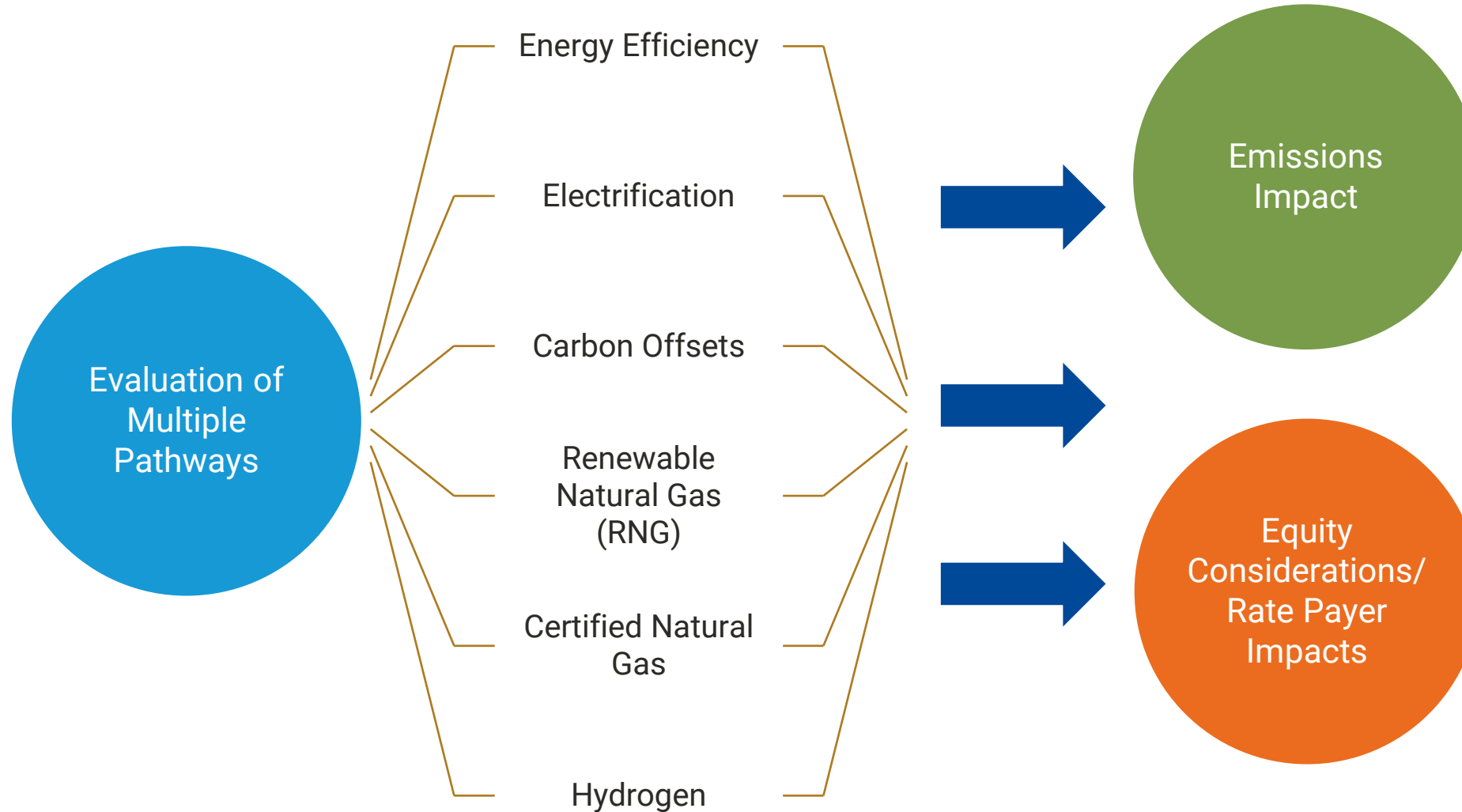

Questions?





Contact Us

Dr. Hua Fang
+1 713-255-3355
Fangh@bv.com
Project Director

**CITY OF CHARLOTTESVILLE, VIRGINIA
CITY COUNCIL AGENDA**



Agenda Date: March 20, 2023

Action Required:

Presenter: John Sales

Staff Contacts: John Sales

Title: Charlottesville Redevelopment and Housing Authority update on sustainability and status with the Department of Housing and Urban Development

Background

Discussion

Alignment with City Council's Vision and Strategic Plan

Community Engagement

Budgetary Impact

Recommendation

Alternatives

Attachments

None

CITY OF CHARLOTTESVILLE



PROCLAMATION

WOMEN'S HISTORY MONTH 2022

WHEREAS, women of every race, class and ethnic background have made historic contributions to the growth and strength of Charlottesville in countless recorded and unrecorded ways; and

WHEREAS, women play a critical economic, cultural and social role in every sphere of life in Charlottesville; and

WHEREAS, particularly important in the establishment of early charitable, philanthropic and cultural institutions in our City, women have served as early leaders in the forefront of every major progressive social change movement; and

WHEREAS, women have been leaders, not only in securing their own rights of suffrage and equal opportunity, but also in the abolitionist, emancipation, industrial labor, civil rights, environmental and peace movements, which have created a more fair and just society for all; and

WHEREAS, despite these contributions, the role of women has consistently been overlooked and undervalued in the literature, leadership, teaching and study of American history and it is therefore fitting that we recognize their numerous accomplishments; and

WHEREAS, the 2022 theme of the National Women's History Month is "Women Providing Healing, Promoting Hope," a recognition of the ceaseless work of caregivers and frontline workers during this ongoing pandemic, and a recognition of the thousands of ways that women of all cultures have provided both healing and hope throughout history; and

WHEREAS, the City of Charlottesville reaffirms its commitment to uplifting and safeguarding women's rightful place in our history and in our society;

NOW, THEREFORE, I, J. Lloyd Snook, III, Mayor of the City of Charlottesville, Virginia, on behalf of the City Council, do hereby proclaim the month of March 2022 in Charlottesville as Women's History Month.

Signed and sealed this 7th day of March 2022.

J. Lloyd Snook, III, Mayor

CHARLOTTESVILLE CITY COUNCIL MEETING

February 21, 2023 at 4:00 p.m.

In person: Council Chamber, 605 E. Main Street

Virtual/electronic: Zoom

The Charlottesville City Council met on Tuesday, February 21, 2023. The meeting was held in hybrid format with Council members and limited public seating in Council Chamber to mitigate health risks related to coronavirus and other communicable diseases, and electronic participation on the Zoom webinar platform. Mayor Lloyd Snook called the meeting to order and Clerk of Council Kyna Thomas called the roll, noting the following councilors present: Brian Pinkston, Mayor Lloyd Snook and Vice Mayor Juandiego Wade.

On motion by Pinkston, seconded by Wade, Council by the following vote ADOPTED the meeting agenda as amended to add a resolution regarding the hiring of an executive search firm to conduct the search for a City Manager: 4-0 (Ayes: Payne, Pinkston, Snook, Wade; Noes: none).

REPORTS

1. REPORT: Polco National Community Survey Presentation

Interim City Manager Michael C. Rogers opened with a summary and introduced Joseph Dell'Olio, Senior Survey Associate with National Research Center for Polco.

Mr. Dell'Olio presented results from the National Community Survey for Charlottesville and compared to national benchmarks. This was the fifth time conducting The National Community Survey in Charlottesville, previous surveys having been conducted in 2012, 2014, 2016 and 2018. Mr. Dell'Olio reported results related to the quality of community livability:

- Overall economic health
- Overall quality of the transportation system
- Overall design or layout of residential and commercial areas
- Overall quality of the utility infrastructure
- Overall feeling of safety
- Overall quality of natural environment
- Overall quality of parks and recreation opportunities
- Overall health and wellness opportunities
- Overall opportunities for education, culture and the arts
- Residents' connection and engagement with their community

Council followed up with questions and Mr. Rogers stated that the information from this report will inform the Strategic Plan.

2. REPORT: State of the Forest - Tree Commission

Steve Gaines, Urban Forester, introduced members of the Tree Commission - Peggy van Yahres, outgoing Chair and Jeff Aten incoming Chair, who presented the State of the Forest annual

report.

The report indicated worsening heat islands in the city and declining tree canopy. The Tree Commission recommended:

- 1) Support of the Comprehensive Plan goal to “Require that zoning changes preserve and enhance natural resources and sensitive environmental areas, designated flood plain areas, steep slopes, rivers, and streams.
- 2) Regarding the Zoning rewrite:
 - Increase requirements for planting new trees and protecting existing trees
 - Establish consequences for public tree damage and incentives for saving trees
 - Eliminate “no setback waivers” which prohibit street tree plantings
 - Encourage new development on degraded land
 - Do not increase density on forests and offer environmentally sensitive lands
 - Protect critical slopes and other environmentally important sites
- 3) Fund the Tree Commission’s FY24 Capital Improvement Plan requests:
 - \$100,000 for new tree plantings
 - \$100,000 for ash tree removals
 - \$75,000 for reduction of invasive plants in parks
 - \$100,000 for preservation and replacement of Downtown Mall trees
- 4) Improve the City’s Organization to better manage natural resources
- 5) Expanding the charge of the Tree Commission

3. REPORT: City of Charlottesville Environmental Standards

James Freas, Director of Neighborhood Development Services, presented information regarding the Environmental Regulatory Program. Four objectives of the program are to:

- 1) Strengthen the City’s water quality protection program with a focus on riparian areas where there are parallel benefits of floodplain management, habitat protection, and tree canopy preservation.
- 2) Ensure that the City’s environmental protection program does not unintentionally disincentivize and redirect development out of the City or result in inequitable land use patterns by balancing environmental and development benefits, targeting regulations to where they can have the greatest environmental benefits, and making the requirements predictable, achievable, and enforceable.
- 3) Promote development that aligns with the City’s developing flood resiliency and climate adaptation plan strategies, which could include green design practices for sites and buildings.
- 4) Match the regulatory program to the City’s staffing capacity and available resources.

Councilors provided feedback.

CLOSED SESSION

Council voted 4-0 (Ayes: Payne, Pinkston, Snook, Wade; Noes: none) to close this open meeting and convene in a closed session, as authorized by Virginia Code Section 2.2-3711(A)(1), for the discussion and consideration of appointing members to the following Charlottesville public bodies:

1. Charlottesville City Council,
2. Charlottesville Affordable Housing Fund Committee
3. Community Development Block Grant (CDBG) and HOME Task Force
4. Housing Advisory Committee (rescinding appointment), and
5. Police Civilian Oversight Board.

On motion by Pinkston, seconded by Wade, Council certified by the following vote: 4-0 (Ayes: Payne, Pinkston, Snook, Wade; Noes: none), that to the best of each Council member's knowledge only public business matters lawfully exempted from the open meeting requirements of the Virginia Freedom of Information Act and identified in the Motion convening the closed session were heard, discussed or considered in the closed session.

BUSINESS SESSION

Council Seat Announcement and Swearing In

On motion by Vice Mayor Wade, seconded by Councilor Pinkston, City Council by a vote of 4-0 (Ayes: Payne, Pinkston, Snook, Wade; Noes: none), appointed Leah Puryear to fill the City Council seat left vacant by Sena Magill.

Clerk of Court Llezelle Dugger administered the Oath of Office, noting term dates of February 27, 2023, through December 31, 2023, and she provided a copy of the Oath to the Clerk of Council.

Councilors and Ms. Puryear made remarks.

ANNOUNCEMENTS

Mayor Snook spoke about meetings scheduled to talk about the modules for the Zoning Ordinance rewrite, and he commended Wes Bellamy for organizing the fundraiser to help the family of Skeeter Smith.

BOARD/COMMISSION APPOINTMENTS

On motion by Pinkston, seconded by Wade, Council by a vote of 4-0 (Ayes: Payne, Pinkston, Snook, Wade; Noes: none) APPOINTED members to the Police Civilian Oversight Board: Charles Fleming, Susan Krischel, George Dillard (non-voting member with law enforcement experience), Lakeshia Washington, Patricia Jones Turner (social justice representative), and reappointing James Watson. The mayor mentioned that terms were being looked at to have term rotation on an annual basis versus the 18-month interval as initially set up.

Council agreed to rescind the appointment of Elise Noyes, whom they appointed on February 6 to the Housing Advisory Committee because she did not meet qualifications.

On motion by Pinkston, seconded by Wade, Council by a vote of 4-0 (Ayes: Payne, Pinkston, Snook, Wade; Noes: none) APPOINTED Helen Sporkin and Richard Fravel to the Charlottesville Affordable Housing Fund.

On motion by Pinkston, seconded by Wade, Council by a vote of 4-0 (Ayes: Payne, Pinkston, Snook, Wade; Noes: none) APPOINTED Sylethia Carr, Jacquana Mason and Helen Sporkin to the Community Development Block Grant-HOME Investment Partnership Task Force.

4. RESOLUTION: Charlottesville Affordable Housing Fund Committee membership, replacing Resolution #R-23-012

Council did not vote on this resolution.

5. RESOLUTION: Appointing the membership of the Community Development Block Grant (CDBG) and Home Investment Partnerships Program (HOME) Task Force, Pursuant to City Code Section 2-417 (1 reading)

Council did not vote on this resolution.

CONSENT AGENDA*

Clerk of Council Kyna Thomas read the following Consent Agenda items into the record. No one from the public came forward to speak about any of the items.

On motion by Pinkston, seconded by Wade, Council by a vote of 4-0 (Ayes: Payne, Pinkston, Snook, Wade; Noes: none) ADOPTED the Consent Agenda.

6. MINUTES: February 6 Council meeting, February 8 joint Council-School Board work session, February 10 and 13 special meetings
7. RESOLUTION: Appropriating funds for Safe Routes to School Program (SRTS) Non-Infrastructure Grants - \$ 229,803 (2nd reading)

**RESOLUTION APPROPRIATING FUNDS for
Safe Routes to School Program (SRTS) Non-Infrastructure Grants \$229,803**

WHEREAS, the Safe Routes to School Program (SRTS) non-infrastructure grant, providing Federal payments for education, encouragement, evaluation and enforcement programs to promote safe walking and bicycling to school has been awarded the City of Charlottesville, in the amount of \$183,842;

WHEREAS, the two year SRTS award is a 80% reimbursement program requiring a 20% match of \$45,961. It will come from in kind donations and volunteer services from Charlottesville Area Mountain Bike Club NOW, THEREFORE, BE IT RESOLVED by the Council of the City of Charlottesville, Virginia that the following is hereby appropriated in the following manner:

REVENUE

\$183,842 Fund: 209 Cost Center: 3901008000 G/L: 430120

EXPENDITURES

(expenditures and salary)

\$79,842 Fund: 209 Cost Center: 3901008000 G/L: 599999

\$104,000 Fund: 209 Cost Center: 3901008000 G/L: 519999

BE IT FURTHER RESOLVED, that this appropriation is conditioned upon the receipt of \$183,842 from the Virginia Department of Transportation.

8. RESOLUTION: Appropriating Supreme Court of Virginia Behavioral Health Docket Grant in the amount of \$61,500 for operations of the therapeutic docket program (2nd reading)

RESOLUTION

Appropriating the Grant for Charlottesville - Albemarle Therapeutic Docket Grant Award in the amount of \$61,500

WHEREAS, the Supreme Court of Virginia awarded the Supreme Court of Virginia Behavioral Health Docket Grant in the amount of \$61,500 for the Charlottesville-Albemarle Therapeutic Docket in order to fund salaries, benefits, and operating expenses; and

WHEREAS, the City of Charlottesville serves as the fiscal agent for this grant program; and

WHEREAS, the City of Charlottesville and Albemarle County both have dedicated local matches to this grant, totaling \$167,200; and

WHEREAS, the grant award covers the period September 1, 2022 through June 30, 2023.

NOW, THEREFORE BE IT RESOLVED by the Council of the City of Charlottesville, Virginia, that the sum of \$61,500, received as a grant from the Supreme Court of Virginia, is hereby appropriated in the following manner:

Revenues

\$61,500 Fund: Internal Order: #1900499 G/L Account: 430110 (State Grant)

Expenditures

\$61,500 Fund: Internal Order: #1900499 G/L Account: 530670

BE IT FURTHER RESOLVED, that this appropriation is conditioned upon the receipt of \$61,500 from the Supreme Court of Virginia.

9. RESOLUTION: Appropriating State Criminal Alien Assistance Program (SCAAP) Grant for 2021 reimbursement in the amount of \$7,743 (2nd reading)

**RESOLUTION APPROPRIATING
State Criminal Alien Assistance Program (SCAAP) Grant for 2021 reimbursement -
\$7,743**

WHEREAS, the State Criminal Alien Assistance Program (SCAAP) grant, providing federal payments for correctional officer salary costs incurred for incarcerating certain undocumented criminals has been awarded the City of Charlottesville, on behalf of the Albemarle-Charlottesville Regional Jail, in the amount of \$7,743.

NOW, THEREFORE BE IT RESOLVED by the Council of the City of Charlottesville, Virginia that a total of \$6,040 be appropriated and passed through to the Albemarle-Charlottesville Regional Jail and \$1,703 be appropriated and passed through to Justice Benefits, Inc.

Revenues

\$7,743 Fund: 211 Internal Order: 1900509 G/L Account: 431110

Expenses

\$6,040 Fund: 211 Internal Order: 1900509 G/L Account: 530550

\$1,703 Fund: 211 Internal Order: 1900509 G/L Account: 530670

BE IT FURTHER RESOLVED, that this appropriation is conditioned upon the receipt of \$7,743 from the U. S. Bureau of Justice Assistance.

10. RESOLUTION: Appropriating funds for appraisal services at 0 East High Street - \$3,800 (2nd reading)

**RESOLUTION APPROPRIATING FUNDING FOR
Appraisal Services at 0 East High Street - \$3,800**

NOW, THEREFORE, BE IT RESOLVED by the City Council of the City of Charlottesville, Virginia that the sum of \$3,800 is hereby paid from currently appropriated funds in the Council Strategic Initiatives account in the General Fund for appraisal services at 0 East High Street.

\$3,800 Fund: 105 Cost Center: 10110010000

11. RESOLUTION: Appropriating funds for the purchase of Charlottesville Area Transit radio equipment - \$237,000 (2nd reading)

RESOLUTION

Appropriating the Amount of \$237,000 from the CIP Contingency funds for the Purchase of Charlottesville Area Transit Radio Equipment

WHEREAS, the radio equipment compatible with the regional emergency communication system does not meet the Federal Transit Administration’s (FTA) Buy America guidelines and;

WHEREAS, Charlottesville Area Transit (CAT) cannot apply any federal FTA funding for the purchase or installation of new radio equipment;

NOW, THEREFORE, BE IT RESOLVED by the Council of the City of Charlottesville, Virginia that the following is hereby transferred from CIP Contingency funds in the following manner:

Transfer From

\$237,000 Fund: 426 WBS: CP-080 G/L Account: 599999

Transfer To

\$237,000 Fund: 426 Internal Order: 1000008 G/L Account: 599999

12. RESOLUTION: Considering a Special Use Permit for the Three Notch'd Brewery Expansion

RESOLUTION

Granting a Special Use Permit for a Small Brewery at 522 2nd Street SE Application SP22-00011

WHEREAS Three Notch’d Brewing Company, LLC (“Applicant”) represents the owners of certain land identified within the City of Charlottesville real estate records by Real Estate Parcel Identification No. 280208100 (the “Subject Property”), which has frontage on 2nd Street SE and Monticello Avenue; and

WHEREAS the Subject Property is located in the Downtown Extended Mixed Use Corridor zoning district, and according to the Use Matrix set forth within City Code 34-796, small breweries are a permissible use of the Subject Property only if authorized by City Council by special use permit; and

WHEREAS the proposed small brewery is described in more detail within the application materials dated September 21, 2022, submitted in connection with SP22-00011, as required by City Code 34-158 (the “Application Materials”); and

WHEREAS the City Council and the Planning Commission conducted a joint public hearing on January 10, 2023, following public notice given in accordance with applicable law; and

WHEREAS the Planning Commission considered and recommended approval of this application at their January 10, 2023 meeting, subject to conditions recommended within the Staff Report; now, therefore,

BE IT RESOLVED by the Council for the City of Charlottesville, Virginia, that a Special Use Permit is hereby granted to allow a small brewery to be established on the Subject Property subject to the following conditions:

1. No expanded brewery production (beyond 15,000 barrels per year) is permitted on the subject property until:
 - a. The Utilities Department confirms existing sanitary sewer facilities can adequately handle the increased biological oxygen demand generated by the expansion in brewery production, or
 - b. Facilities on the subject property are upgraded to address the increased biological oxygen demand, and the Utilities Department confirms the upgraded facilities will adequately handle the increased demand.

13. RESOLUTION: Appropriating funds for reimbursement of United Way Community Resource Hotline Staff Costs - \$45,559.02 (carried)

14. RESOLUTION: Authorizing Signature Authority for Virginia Department of Transportation (VDOT)

RESOLUTION

AFFIRMING THE CITY OF CHARLOTTESVILLE, VIRGINIA'S COMMITMENT TO FUND THE LOCALITY SHARE OF PROJECTS PURSUANT TO AGREEMENT WITH THE VIRGINIA DEPARTMENT OF TRANSPORTATION AND TO PROVIDE SIGNATURE AUTHORITY

WHEREAS, the City of Charlottesville, Virginia (the "City") is a recipient of Virginia Department of Transportation ("VDOT") funds under various grant programs for transportation- related projects; and

WHEREAS, in order to receive VDOT funds under said grant programs, the governing body of a locality must, by resolution, provide assurance to VDOT of its commitment to funding its local share; now therefore,

BE IT RESOLVED, by the Council for the City of Charlottesville, Virginia, that the City commits to provide funding sufficient to meet its local share of preliminary engineering, right- of-way, and construction (as applicable) of the project(s) under agreement with VDOT in accordance with each project's financial document(s); and,

BE IT FURTHER RESOLVED, that the City Manager for the City of Charlottesville, Virginia, and/or his designees is authorized to execute all agreements and/or addendums on behalf of the City for any approved projects with VDOT.

In witness whereof, the forgoing was adopted by City Council of Charlottesville, Virginia on February 21, 2023.

15. RESOLUTION: Supporting redevelopment of 1025 Park Street A & B (formerly MACAA Redevelopment)

RESOLUTION

**Financial Resolution Supporting 1025 Park Street A & B (f/k/a MACAA) Parcel
Number: 470007100**

NOW, THEREFORE BE IT RESOLVED that the Council of the City of Charlottesville, Virginia hereby commits up to \$3,770,000 in the form of grants for the development of 1025 Park Street A & B (f/k/a MACAA redevelopment project) subject to Piedmont Housing Alliance satisfying the conditions of a Memorandum of Understanding agreed to by the City and Piedmont Housing Alliance. The commitment of up to \$3,770,000 will help to subsidize 1025 Park Street A & B which in turn will create approximately 86 newly constructed affordable housing units in the City of Charlottesville. This commitment will be made to Piedmont Housing Alliance.

CITY MANAGER REPORT

Mr. Rogers spoke about the train derailment in Ohio and stated that he has a report from the Fire Department; he read a statement from the city's Emergency Manager regarding the City of Charlottesville's readiness to respond during any need for emergency management.

COMMUNITY MATTERS

Mayor Snook opened the floor for comments from the public.

1. Matthew Gillikin on behalf of CLIHC (Charlottesville Low Income Housing Coalition), spoke about a book *Homelessness is a Housing Problem*, and the increase of homelessness as indicated by the most recent Point-in-Time (PIT) count. He gave copies of the book to Council members and asked them to pass it along once they finish reading it, as well as implement lessons so that homelessness "will be rare, brief and non-recurring".

ACTION ITEMS

16. By Motion: 507 Ridge Street - BAR Denial of a Certificate of Appropriateness for Demolition of Cottage/Shed (BAR 22-11-03)

Jeff Werner, Preservation Design Planner and staff representative for the Board of Architectural Review (BAR), summarized the appeal and the appeal process as outlined in the City Code. He noted that Council may consider factors that were not under the purview of the review criteria for the BAR.

Clayt Lauter, appellant, presented what he considered a win-win for the City. The proposal

was to demolish the current appurtenant structure and construct an accessory dwelling unit to house his aging parent.

Breck Gastinger, Chair for the BAR, read a statement into the record:

" Members of City Council:

- The BAR carefully considered the demolition application on two occasions (Nov 15 and Dec 20, 2022), aided by client presentations and a thorough staff report.
- The proposed demolition is of a small structure behind the significant Gianniny-Bailey House on Ridge Street. Though small, this shed is both old (1895) and unique, and has been identified as a contributing structure in the Ridge Street Architectural Design Control District and the National Register's Ridge Street Historic District. The city historical survey from 1994 identifies this as one of 3 remaining servants' quarters in the District. It is unclear that any others remain today. Sometimes, these seemingly insignificant structures can be an important thread of our community history. The relationships between this building and the larger historic home reflect past social relationships that are part of Charlottesville. The city's ADC District Design Guidelines and the Secretary of Interior's Standards for Historic Preservation are clear that demolition of such structures should be a last resort and only when there is a benefit to the public and other alternatives have been exhausted.
- The applicant demonstrated little interest in preserving the structure, either in its current location or by other means. Nor was the BAR presented documentation prepared by a qualified professional who evaluated the condition and integrity of this building and made clear that demolition was required.
- After careful consideration of the application and the standards within the city code and the Design Guidelines, the BAR voted 4 – 2 to deny the CoA."

On motion by Pinkston, seconded by Payne, Council by a vote of 4-0 (Ayes: Payne, Pinkston, Snook, Wade; Noes: none) APPROVED the Certificate of Appropriateness for demolition of a cottage/shed at 507 Ridge Street. Councilor Payne encouraged the applicant to have the shed documented, as he indicated that he would with the architectural history value discussed by the BAR. Council acknowledged that historic preservation in this case would be overburdensome to the property owner. Vice Mayor Wade thanked the BAR and noted the restricted parameters within their review guidelines.

17. RESOLUTION: Appropriating funds in support of BEACON's Kitchen Project - \$500,000 (2nd reading, amended)

Chris Engel, Director of Economic Development, summarized the language revisions to the resolution, which were requested during the February 6 City Council meeting.

On motion by Pinkston, seconded by Payne, Council by a vote of 4-0 (Ayes: Payne, Pinkston, Snook, Wade; Noes: none) APPROVED the resolution in support of BEACON's kitchen project.

RESOLUTION

New Hill Development Corporation - BEACON's Kitchen Project \$500,000

NOW, THEREFORE, BE IT RESOLVED by the City Council of the City of Charlottesville, Virginia that the sum of \$500,000 is hereby authorized to be allocated from currently appropriated funds in the ARP Strategic Investment Account (\$500,000) to New Hill Development Corporation upon the drafting of an approved Donation Agreement between the City of Charlottesville and New Hill Development Corporation and pursuant to said Agreement, the City Manager is hereby authorized to execute the Donation Agreement with New Hill Development Corporation.

\$500,000 Fund: 207 I/O:1900491

18. RESOLUTION: Authorizing City Council to engage an executive search firm to assist in the selection of a new City Manager and for the Mayor to execute documents related thereto

Mayor Snook explained that the Request for Quotes received five responses and Council interviewed two firms.

On motion by Pinkston, seconded by Payne, Council by a vote of 4-0 (Ayes: Payne, Pinkston, Snook, Wade; Noes: none) APPROVED the following resolution.

RESOLUTION

Authorizing City Council to Engage the Executive Search Firm POLIHIRE to Assist the Charlottesville City Council in the selection of a new City Manager and for the Mayor to Execute Documents Related Thereto.

WHEREAS the City of Charlottesville, Virginia (the "City") is currently served by an Interim City Manager; and

WHEREAS the City issued a Request for Quotations ("RFQ") to assist the Charlottesville City Council in the selection of a new City Manager (the "Services"); and

WHEREAS the Services are more fully described in RFQ #23-56; and

WHEREAS the Interim City Manager has recused himself from all aspects of procuring said Services;

WHEREAS City Council has the power to award a contract to procure the Services pursuant to City Code Sec. 2-36; and

WHEREAS City Council desires to engage the firm of POLIHIRE to provide said Services; and

WHEREAS City Council has the power to authorize the Mayor of the City of Charlottesville to execute documents necessary to engage POLIHIRE to provide said Services pursuant to City Code Sec. 2-36; now therefore,

BE IT RESOLVED by the Council for the City of Charlottesville, Virginia, that City Council shall engage POLIHIRE to assist the Charlottesville City Council in the selection of a new City Manager; and

BE IT FURTHER RESOLVED that the Mayor for the City of Charlottesville is authorized to execute documents, approved as to form by the City Attorney, to retain POLIHIRE to assist the Charlottesville City Council in the selection of a new City Manager.

OTHER BUSINESS

Vice Mayor Wade asked for follow-up regarding whether the traffic signal at Water Street and Nations Bank (3rd Street) is necessary.

COMMUNITY MATTERS (2)

Mayor Snook opened the floor for public comment. No speakers came forward.

The meeting adjourned at 7:46 p.m.

BY Order of City Council

BY Kyna Thomas, Clerk of Council

CHARLOTTESVILLE CITY COUNCIL MEETING

March 6, 2023 at 4:00 p.m.

In person: Council Chamber, 605 E. Main Street

Virtual/electronic: Zoom

The Charlottesville City Council met on Monday, March 6, 2023. The meeting was held in hybrid format with Council members and public seating in Council Chamber, and electronic participation on the Zoom webinar platform. Mayor Lloyd Snook called the meeting to order, and Clerk of Council Kyna Thomas called the roll, noting the following councilors present: Mayor Lloyd Snook, Vice Mayor Juandiego Wade and Councilors Michael Payne, Brian Pinkston and Leah Puryear.

On motion by Pinkston, seconded by Wade, Council by the following vote ADOPTED the meeting agenda: 5-0 (Ayes: Payne, Pinkston, Puryear, Snook, Wade; Noes: none).

REPORTS

1. PRESENTATION: Update on Transportation Planning

Ben Chambers, Transportation Planning Manager, made the presentation. The City's Transportation goals include:

- GOAL 1: Complete Streets
- GOAL 2: Coordination with Land Use and Community Design
- GOAL 3: Efficient Mobility and Access
- GOAL 4: Parking Supply and Management
- GOAL 5: Transit System
- GOAL 6: Regional Transportation
- GOAL 7: Sustainable Transportation Infrastructure
- GOAL 8: Infrastructure Funding

Using the 3 Cs of Transportation Planning: Comprehensive, Continuous, and Collaborative, Mr. Chambers was able to analyze the City's challenges with transportation planning. He reviewed city transportation planning activities and programs, focusing on the following topics:

- CAT Alternative Fuels Feasibility Study
- Safe Streets and Roads for All Action Plan
- Non-motorized Infrastructure Prioritization Process, and
- Dockless permit regulations revisit.

Council emphasized the need for public education on the use of dockless transportation, reporting misplaced units, and incentivizing proper use.

Mr. Chambers reviewed next steps and stated that the priority list should come before Council in Summer 2023. Council requested that the list of priorities be accessible to the public, and that regular updates on capital projects be provided to City Council.

CLOSED SESSION

On motion by Pinkston, seconded by Wade, Council voted 5-0 (Ayes: Payne, Pinkston, Puryear, Snook, Wade; Noes: none) to meet in closed session:

- as authorized by Virginia Code Section 2.2-3711(A)(1), to discuss the following appointments:
 1. To the Charlottesville Affordable Housing Fund Committee; and
 2. To certain board and committee seats; and
- as authorized by Virginia Code Section 2.2-3711(A)(8) for consultation with legal counsel retained by Council specifically regarding the City's collective bargaining negotiation process and subsequent agreements.

On motion by Pinkston, seconded by Payne, Council certified by the following vote: 5-0 (Ayes: Payne, Pinkston, Puryear, Snook, Wade; Noes: none), that to the best of each Council member's knowledge only public business matters lawfully exempted from the open meeting requirements of the Virginia Freedom of Information Act and identified in the Motion convening the closed session were heard, discussed or considered in the closed session.

BUSINESS SESSION

City Council began the Business Session by observing a moment of silence.

ANNOUNCEMENTS

Councilor Payne announced that the deadline for real estate tax relief was extended to March 10.

Mayor Snook announced Fix a Leak Week.

Vice Mayor Wade announced the "My Help List" Contest by Mr. Alex-Zan.

Councilor Pinkston announced a climate action event "Acting on Climate Together" on March 15 at Carver Recreation Center.

RECOGNITIONS/PROCLAMATIONS

- **PROCLAMATION: 2023 Virginia Festival of the Book, March 23-26**

Councilor Payne presented the proclamation to Kalela Williams.

- **PROCLAMATION: March for Meals Month**

Vice Mayor Wade presented the proclamation to Robin Goldstein, Executive Director of Meals on Wheels Charlottesville/Albemarle. Ms. Goldstein thanked everyone for the recognition and support.

- **PROCLAMATION: Multiple Sclerosis Awareness Month**

Councilor Puryear presented the proclamation to Ashley Collier who lives with Multiple

Sclerosis.

- **PROCLAMATION: Red Cross Month**

Councilor Pinkston presented the proclamation to Bill Brent of the American Red Cross, Charlottesville Chapter. Mr. Brent accepted and provided additional information about The American Red Cross’s partnership with the locality.

BOARD/COMMISSION APPOINTMENTS

Mayor Snook announced that Councilor Puryear will represent City Council on the Legislative Committee, Community Criminal Justice Board, Virginia First Cities, and the Charlottesville Community Scholarship Program. He also announced that he will represent Council on the Historic Resources Committee.

2. RESOLUTION: Appointing CAHF Subcommittee Members and establishing staggered terms

Deputy City Manager Sanders provided clarity regarding the appointment of one member to the open at-large community member seat.

On motion by Pinkston, seconded by Puryear, Council by the following vote rescinded the appointment of two people made on February 21 and appointed Richard Fravel to the open seat: 5-0 (Ayes: Payne, Pinkston, Puryear, Snook, Wade; Noes: none).

RESOLUTION

Appointing the membership of the Charlottesville Affordable Housing Fund Committee

WHEREAS on April 4, 2022, by resolution #R-22-039 the Charlottesville City Council established a new advisory body, to be known as “The Charlottesville Affordable Housing Fund Committee”, and

WHEREAS City Council desires to appoint the initial membership of the committee, and to make the appointments in a manner that will stagger the initial terms; **now, therefore,**

BE IT RESOLVED by the Council of the City of Charlottesville that the following individuals are hereby appointed to serve on the Charlottesville Affordable Housing Fund Committee, for the terms specified below:

Seats	Expiration of Initial Term	Name
Asterisk (*) denotes eligibility requirements		
At Large Community Members (3)	12/31/2025 (3 years)	Philip D’Oronzio (appointed 1/17/23)
	12/31/2024 (2 years)	S. Lisa Herndon (appointed 1/17/23)

	12/31/ 2023 (1 year)	Richard Fravel (appointed 3/6/23)
Affordable Housing Beneficiaries* (3) (*must be a current resident of an affordable dwelling unit)	12/31/2025	Open
	12/31/2024	Open
	12/31/2023	Open
City Staff* (3) (*must be a full-time city employee)	Term coextensive with time in position	Housing Program Manager (Taylor Harvey-Ryan)
	Term coextensive with time in position	Finance Director (Chris Cullinan)
	Term coextensive with time in position	Human Services Director (Misty Graves)

BE IT FURTHER RESOLVED that each of these appointments is made subject to the provisions of City Code Chapter 2, Article I, Sec. 2-8 (Limitation on terms of members of boards and commissions). Upon the expiration of the initial terms specified above, all appointments and re-appointments shall be for two (2) year terms. Pursuant to City Code Sec. 2-8(c), an individual initially appointed to a term of less than two (2) years may thereafter serve four complete terms of two (2) years each. City staff seats will have no term limitation.

BE IT FURTHER RESOLVED that, if an individual appointed to serve as an affordable housing beneficiary becomes ineligible during their appointed term, that individual’s seat shall be deemed to be vacant, and City Council will appoint an eligible individual to fill the unexpired portion of the term. If an individual appointed to serve a city staff seat leaves the designated position, the person hired to fill the position will also fill the seat vacancy.

CONSENT AGENDA*

Clerk of Council Kyna Thomas read the following Consent Agenda items into the record:

- 3. MINUTES: February 28 joint Planning Commission-City Council work session**
- 4. RESOLUTION: Appointing CDBG Task Force Members and establishing staggered terms**

RESOLUTION

Appointing the membership of the Community Development Block Grant (CDBG) and Home Investment Partnerships Program (HOME) Task Force, Pursuant to City Code Section 2-417

WHEREAS City Council desires to appoint the initial membership of the reconfigured task force, and to make the appointments in a manner that will stagger the initial terms; **now, therefore,**

BE IT RESOLVED by the Council of the City of Charlottesville that the following individuals are hereby appointed to serve on the CDBG and HOME Task Force, for the terms specified below:

Seats	Expiration of Initial Term	Name
Asterisk (*) denotes eligibility requirements		
Pursuant to City Code 2-417 (b)(1), Five (5) CDBG/HOME Area Community Members* (*must reside within a HUD-identified income eligible area AND must reside within a City-Council designated priority neighborhood). These Neighborhoods are as follows:	Term Options: 12/31/25 (3 years) (1) 12/31/24 (2 years) (2) 12/31/23 (1 year) (2)	
Belmont Neighborhood	Select Term: 1yr; 2yrs; 3yrs	Open
Fifeville Neighborhood	12/31/2025	Jacquana Mason
10 th & Paige Neighborhood	Select Term: 1yr; 2yrs; 3yrs	Open
Ridge Street Neighborhood	Select Term: 1yr; 2yrs; 3yrs	Open
Rose Hill Neighborhood	12/31/2024	Sylethia Carr
At-Large Community Member (1)	12/31/2025	Helen Sporkin
Charlottesville Planning Commission Representative (1)	Term is coextensive with Planning Commission appointment	Phil D’Oronzio
School Board Representative (1)	Term is coextensive with School Board appointment	James Bryant
Public Service Program Representative* (1) (*must be a member of the governing board of the	12/31/2023	Connor Brew

BE IT FURTHER RESOLVED that each of these appointments is made subject to the provisions of City Code Chapter 2, Article XIII, Sec. 2-417 (Community development block grant and HOME task force). Upon the expiration of the initial terms specified above, all subsequent appointments and re-appointments shall be for terms of three years each. Pursuant to City Code Sec. 2-8(c), an individual initially appointed to a term of less than three years may thereafter serve two complete terms of two (2) years each.

BE IT FURTHER RESOLVED that, if an individual appointed to serve as an affordable housing beneficiary, an at-large community member or a public service program representative, becomes ineligible during their appointed term, that individual’s seat shall be deemed to be vacant, and City Council will appoint an eligible individual to fill the unexpired portion of the term.

5. RESOLUTION: Re-establishing term dates for Police Civilian Oversight Board

RESOLUTION

Establishing the City Council’s February 21, 2023, Appointments to the Police Citizen Oversight Board (PCOB) and Confirming the Terms for PCOB Members on a Staggered Schedule, Pursuant to City Code Section Sec. 2-453

WHEREAS City Council appointed members to the City’s PCOB on February 21, 2023, and such appointments are in compliance with City Code Sec. 2-453; and

WHEREAS, City Council desires to establish through Resolution the appointments and the respective terms of each appointed member; and

WHEREAS, the City Council seeks to stagger the terms; **now, therefore**,

BE IT RESOLVED by the Council of the City of Charlottesville that the following individuals are hereby appointed to serve on the PCOB, for the terms specified below:

Seats	Term Expiration	Name
Asterisk (*) denotes eligibility requirements		
The board shall reflect the demographic diversity of the City with seven (7) voting members and one (1) non-voting member pursuant to City Code Sec. 2-453 (b).	Three (3) year terms. Appointments and terms shall be subject to City Code Sec. 2-8.	
Community Resident Member A pursuant to City Code Sec. Sec. 2-453 (b)(1).	8/31/2026	Charles Fleming
Community Resident Member B pursuant to City Code Sec. Sec. 2-453 (b)(1).	8/31/2024	Lakeshia Washington
Community Resident Member C pursuant to City Code Sec. Sec. 2-453 (b)(1).	8/31/2024	James Watson
Social Justice Organization Member pursuant to City Code Sec. Sec. 2-453 (b)(2).	8/31/2026	Patricia Jones Turner
City Resident At-Large Member A pursuant to City Code Sec. Sec. 2-453 (b)(4).	8/31/2026	Susan Krischel

City Resident At-Large Member B pursuant to City Code Sec. Sec. 2-453 (b)(4).	8/31/2024	William Mendez
City Resident At-Large Member C pursuant to City Code Sec. Sec. 2-453 (b)(4).	8/31/2024	Jeffrey Fracher
City Non-Voting Member pursuant to City Code Sec. Sec. 2-453 (b)(3).	8/31/2026	George Dillard

BE IT FURTHER RESOLVED that each of these appointments is made subject to the provisions of City Code Chapter 2, Article XVI (Police Civilian Oversight Board). Upon the expiration of the terms specified above, all subsequent appointments and re-appointments shall be for terms of three years each. Pursuant to City Code Sec. 2-8(c), an individual initially appointed to a term of less than three years may thereafter serve two complete terms of three (3) years each.

BE IT FURTHER RESOLVED that, if an individual appointed to serve as a Community Resident Member, City Resident At-Large Member or a Social Justice Organization Member, becomes ineligible during their appointed term, that individual's seat shall be deemed to be vacant, and City Council will appoint an eligible individual to fill the unexpired portion of the term.

6. RESOLUTION: Appropriating funds for reimbursement of United Way Community Resource Hotline Staff Costs - \$45,559.02 (2nd reading)

RESOLUTION

Appropriating the Amount of \$45,559.02 Received from The United Way, as reimbursement of Community Resource Hotline Staff Costs and Emergency Hotel Stays

WHEREAS, The City of Charlottesville, through the Department of Human Services, has received reimbursement from the United Way of Greater Charlottesville in the amount of \$45,559.02;

NOW, THEREFORE BE IT RESOLVED by the Council of the City of Charlottesville, Virginia that the sum of \$45,559.02 is hereby appropriated in the following manner:

Revenues

\$40,557.19 Fund: 213 Cost Center: 3411001000 G/L: 451022

\$5,002.83 Fund: 213 Cost Center 3411002000 G/L: 530102

Expenditures

\$40,557.19 Fund: 213 Cost Center: 3411001000 G/L: 599999

\$5,002.83 Fund: 213 Cost Center: 3411002000 G/L: 530102

7. RESOLUTION: Considering a Critical Slope Waiver Application request at 1000 Cherry Avenue (Buford Middle School)

RESOLUTION

Granting a critical slope waiver for the properties located at 1000 Cherry Avenue

WHEREAS The City of Charlottesville (“Landowner”) is the owner of certain land identified within the City of Charlottesville Real Estate Assessor’s records as Tax Map and Parcel Nos. 230192000, said parcels having current street addresses of 1000 Cherry Avenue (collectively, the “Subject Property”); and

WHEREAS the Subject Property contains critical slopes, over and within an area of approximately 1.55 acres, which is approximately 8.22% of the combined area of the Subject Property, and Landowner is requesting a waiver of the critical slopes requirements of City Code Sec. 34-1120(b)(6)(b), in connection with the Owner’s plan to renovate and expand Buford Middle School and surrounding infrastructure on the Subject Property (the “Project”); and

WHEREAS the Project is described in more specific detail within the application materials submitted in connection with waiver application no. P22-0132, as required by City Code §34-1120(b)(6) (collectively, the “Application Materials”); and

WHEREAS the Planning Commission considered and recommended approval of this application at their February 14, 2023, meeting, subject to one condition proposed within the Staff Report, therefore,

BE IT RESOLVED by the Council for the City of Charlottesville, Virginia, that a waiver is hereby granted of the critical slopes requirements for the Project, to allow for the renovation and expansion Buford Middle School and surrounding infrastructure as described within the Application Materials, subject to the following condition:

(1) The applicant will work with the City’s Urban Forester on tree preservation and replanting.

8. RESOLUTION: Settlement for Opioid Related Claims (carried)

9. BY MOTION: Approving disposition of wood from Downtown Mall trees

Mayor Snook opened the floor for public comment on the Consent Agenda. No speakers came forward.

On motion by Pinkston, seconded by Payne, Council by a vote of 5-0 (Ayes: Payne, Pinkston, Puryear, Snook, Wade; Noes: none) ADOPTED the Consent Agenda.

CITY MANAGER REPORT

Interim City Manager Rogers reported on the Employee Compensation Study and stated that the progress will take a while longer than the previously announced February 15 completion date. He acknowledged incidents of gun violence and the efforts of the police department. He stated that

Chief Kochis is looking into an emergency alert program for the city organization, and the Information Technology Department will look into alerts for citizens. He mentioned that the airport is extending service with new airlines. Mr. Rogers noted that collective bargaining will kick off later in Spring and that the Downtown Mall Committee had a productive meeting.

Mr. Sanders reported on SPCA concerns and plans to have the organization provide a report to City Council.

COMMUNITY MATTERS

1. Downing Smith, city resident, thanked Mr. Rogers and the current City Council for putting the city on the right path. He urged Council to consider Mr. Rogers for the City Manager position. He spoke about poor treatment of police and requested a Police Appreciation Day and reinstating National Night Out. He spoke in support of The BUCK Squad and utilizing speed cameras around schools.
2. Dave Norris, city resident, spoke about the city's Zoning Ordinance as related to distribution of poverty and inequity in opportunity. He urged Council to insist on strong affordability provisions as they increase density in the city.
3. Elizabeth Stark, city resident, spoke about the impact of Pathways rent relief funds on residents and about the need for density in the upcoming Zoning rewrite.
4. Emily Smith, housing attorney with Legal Aid Justice Center; speaking on behalf of CLIHC (Charlottesville Low Income Housing Coalition), recommended more density in ___neighborhoods; more height; more affordability.
5. Laura Goldblatt, city resident, spoke about human impact of zoning. Using zoning to increase diversity, density and affordability.

ACTION ITEMS

10. ORDINANCE: Re-precincting the City of Charlottesville (2nd reading)

Taylor Yowell, Voter Registrar, stated that she received three concerns during the public comment period from concerned citizens. She reported on public education and awareness efforts and stated that the benefits outweigh the loss of a small amount of walkability.

Anne Hemenway, Electoral Board, spoke about benefits of bringing on several schools as precincts.

Katrina Callsen, attorney, stated that although names of schools may change, there would be no need to bring the item forward for Council action because of a name change since the location remains the same. The new precincts will go into effect April 7, 2023.

Councilors suggested a public education campaign if schools undergo name changes.

On motion by Pinkston, seconded by Wade, Council by a vote of 5-0 (Ayes: Payne, Pinkston, Puryear, Snook, Wade; Noes: none) APPROVED the ordinance.

**ORDINANCE AMENDING AND RE-ORDAINING CHAPTER 9 (ELECTIONS),
SECTION 9-1 (DESIGNATION AND BOUNDARIES OF WARDS),
SECTION 9-27 (FIRST WARD), SECTION 9-28 (SECOND WARD),
SECTION 9-29 (THIRD WARD),
AND SECTION 9-30 (FOURTH WARD),
TO CHANGE THE PRECINCT BOUNDARIES AND VOTING PLACES.**

WHEREAS, pursuant to Va. Code Section 24.2-307, City Council must be notified and undertake a precinct boundary revision process whenever the number of voters who voted in a precinct in an election for President of the United States exceeds 4,000, and

WHEREAS, the Johnson precinct in Charlottesville exceeded 4000 voters in a presidential election and several other precincts approached the same threshold, and

WHEREAS, large increases in voter registration since 2010 have created consistent logistical issues with two current polling places, Tonsler and Alumni Hall, and

WHEREAS, in 2021 and 2022 a Reprecincting Committee consisting of several community members, the Electoral Board Chair and the City Registrar, met to discuss the current polling places, number of voters at those places, where the population growth has occurred since 2010, where development was either underway or in the proposal state, and possible new polling places, and

WHEREAS, the Reprecincting Committee arrived at the attached proposed Map which eliminates Tonsler and Alumni Hall as polling places, proposes Jackson Via Elementary School and Charlottesville High School as new polling places, redraws precinct boundaries to distribute voters among the precincts, and amends ward descriptions to encapsulate those changes, and

WHEREAS, City Council had a first reading of the proposed ordinances changes during a public meeting held on January 17, 2023, and

WHEREAS, pursuant to Va. Code Section 24.2-129(B), City Council and the General Registrar accepted public comment via mail, email, fax, phone, or in person for a period greater than 30 days to allow the public the opportunity to provide input on the Map and proposed changes, and

WHEREAS, pursuant to Va. Code Section 24.2-129(B), City Council held a public hearing on February 6, 2023 to give the public an opportunity to comment on the Map and proposed precinct changes, and

WHEREAS, the Public Hearing and Public Comment Period were widely advertised to the public to promote participation, and

WHEREAS, no further amendments or changes were recommended for approval by City Council.

NOW, THEREFORE, BE IT ORDAINED by the Council of the City of Charlottesville, Virginia that the City of Charlottesville's shall amend and re-ordain Chapter 9 (Elections) of the City Code to reflect the proposed Map which eliminates Tonsler and Alumni Hall as polling places, proposes Jackson Via Elementary School and Charlottesville High School as new polling places, redraws precinct boundaries to distribute voters among the precincts, and amends ward descriptions to encapsulate those changes.

BE IT FURTHER ORDAINED by the Council of the City of Charlottesville, Virginia that, pursuant to Va. Code Section 24.2-129(C), these precinct changes shall be published on the City of Charlottesville's web site and in the Daily Progress, and a 30 day waiting period will occur prior to enactment to allow affected voters to bring legal challenge.

BE IT FURTHER ORDAINED by the Council of the City of Charlottesville, Virginia that these ordinance changes shall be effective on April 7th, 2023.

BE IT FURTHER ORDAINED by the Council of the City of Charlottesville, Virginia that, after enactment, notice will be provided to all affected voters through direct mail, and

BE IT FURTHER ORDAINED by the Council of the City of Charlottesville, Virginia that, after enactment, the City and the General Registrar will comply with all relevant statutes and ensure proper notice and filing of precinct changes with applicable local and state departments.

11. RESOLUTION: Appropriating funding from the Virginia Land Conservation Fund for Moores Creek Parkland Acquisition - \$175,000 (1 of 2 readings)

This item was moved to a future meeting at staff request

GENERAL BUSINESS

12. PRESENTATION: Presentation of the Charlottesville City Schools Fiscal Year 2024 Annual Budget proposal

James Bryant, School Board Chair and Dr. Royal Gurley, Superintendent, presented the City Schools FY 2024 Annual Budget proposal with the following priorities:

- Building Up Foundational Skills
- Supporting Social, Emotional, and Mental Health for Students & Staff
- Meeting or Exceeding Competitive Staff Compensation & Benefits

Mr. Bryant emphasized the positive outcomes from collaboration and addressing needs from a holistic view.

In response to questions from Council, Ms. Renee Hoover, Director of Finance for Charlottesville City Schools addressed the funding error made at the State level and advised that the FY24 budget was built on the Governor's budget; Dr. Gurley stated that collective bargaining will not have an impact on the current budget; and Dr. Gurley shared data regarding students

using English as a Second Language services. Councilors commended the continuity of workforce development programming at CATEC and in the schools.

13. PRESENTATION: City Manager Presentation of the Proposed Fiscal Year 2024 City Budget

Interim City Manager Michael C. Rogers introduced the budget presentation.

Krisy Hammill, Budget Director, demonstrated the interactive budget book on the City website at www.Charlottesville.gov/budget.

Mr. Rogers highlighted major budget themes:

- Strong Support for City Schools
- Furthers Council Priorities
- Invests in City Employees
- Preserves Quality Services
- Focuses on Organizational Improvements and Efficiencies
- Maintains all current tax rates

Ms. Hammill reviewed the Capital Improvement Program and shared the upcoming budget work session dates.

COMMUNITY MATTERS (2)

Mayor Snook opened the floor for comments from the public.

- Andrea Massey, city resident, spoke in support of the recommendations from CLIHC for deeply affordable housing; more density in historically exclusionary neighborhoods; and increased height in more neighborhoods, tax abatements for affordable units and encouraging partnership with voucher providers.
- Joy Johnson, city resident, spoke in support of recommendations from CLIHC. She asked for definition of "affordable housing".

ADJOURNMENT

Mayor Snook adjourned the meeting at 8:25 p.m.

BY Order of City Council

BY Kyna Thomas, Clerk of Council

CHARLOTTESVILLE CITY COUNCIL
Budget Development Work Session March 9, 2023, at 6:00 PM
In person: CitySpace, 100 5th Street NW
Electronic: Zoom, www.charlottesville.gov/zoom

The Charlottesville City Council met on Thursday, March 9, 2023 in a budget work session to discuss the Fiscal Year 2024 City budget Revenues and Expenses. The meeting was held in hybrid format with Council members and public seating in CitySpace and electronic participation on the Zoom webinar platform. Mayor Lloyd Snook called the meeting to order at 6:02 p.m. Deputy Clerk of Council Maxicelia Robinson called the roll, noting all councilors present: Michael Payne, Brian Pinkston, Leah Puryear, Lloyd Snook, and Juandiego Wade.

FY 2024 Budget Development – Revenues and Expenses

Interim City Manager Michael C. Rogers provided a summary of the proposed new positions in the Fiscal Year 2024 budget.

Krisy Hammill, Director of Budget gave an overview General Fund expenditures and Major Budget Themes:

- Strong support for City Schools
- Furthers Council priorities
- Invests in City employees
- Preserves quality services
- Focuses on Organization improvement and efficiencies
- Maintains all current tax rates

Staff answered questions from Council regarding the Office of Racial Equity, Diversity and Inclusion, additional funding requested for the Blue Ridge Regional Detention Center, funding for the Charlottesville Albemarle Convention and Visitors Bureau, the City Hall ambassador position, and the topic for the next budget work session.

Mr. Sanders provided a summary of efforts to address SPCA concerns.

The following departments made presentations about their operations and answered questions from City Council:

- Fire –Michael Thomas, Interim Chief
- Parks and Recreation – Riaan Anthony, Deputy Director
- Police – Michael Kochis, Chief
- Public Works – Stacey Smalls, Director
- Transit – Garland Williams, Director

A common theme among departments was the challenges faced with recruitment, retention and employment market competitiveness.

Public Comment

Mayor Snook opened the floor for public comment.

- Sandra Aviles Poe with Charlottesville United for Public Education spoke about issues facing schools and prioritizing school budget issues. She spoke about safety and the need to put into place healing mechanisms for children.

With no additional speakers coming forward, Mayor Snook adjourned the meeting at 8:38 p.m.

BY Order of City Council

BY Kyna Thomas, Clerk of Council

DRAFT

**CITY OF CHARLOTTESVILLE, VIRGINIA
CITY COUNCIL AGENDA**



Agenda Date:	March 20, 2023
Action Required:	Approval of Resolution
Presenter:	Ashley Marshall, Deputy City Manager
Staff Contacts:	Ashley Marshall, Deputy City Manager
Title:	Settlement for Opioid Related Claims (2nd reading)

Background

A formal communication from the National Opioids Settlements Implementation Administrator went out to all Virginia cities and counties in February 2023 concerning the proposed settlement of opioid-related claims against Teva, Allergan, Walmart, Walgreens, CVS, and their related corporate entities. All litigating localities are required to have their governing bodies approve a resolution pertaining to this additional settlement.

Discussion

The City of Charlottesville approved and adopted the Virginia Opioid Abatement Fund and Settlement Allocation Memorandum of Understanding and affirmed that any pending settlement would be subject to that Virginia MOU. Settlements for the "Distributors" (McKesson, Cardinal Health, and AmeriSource Bergen) as well as for Johnson & Johnson/Jansen were finalized on October 18, 2022. In late 2022, agreements were announced with three pharmacy chains—CVS, Walgreens, and Walmart—and two additional manufacturers—Allergan and Teva. In January 2023, each of those pharmacy chains and manufacturers confirmed that a sufficient number of states had agreed to the settlements to move forward. As with the 2021 National Settlements, states and local governments that want to participate in the 2022 National Settlements now will have the opportunity to "opt-in." Through this resolution, the City of Charlottesville is exercising its right to legally opt into the settlement by Teva, Allergan, Walmart, Walgreens, and CVS.

Alignment with City Council's Vision and Strategic Plan

N/A

Community Engagement

N/A

Budgetary Impact

None.

Recommendation

It is recommended that the council approves the required resolution to opt into the Teva, Allergan, Walmart, Walgreens, and CVS opioid settlement.

Alternatives

The City Council can refuse to opt-in and thereby forfeit any payments to the locality.

Attachments

1. Opioid Settlement Participation Agreement TEVA etc.
2. Dec06 2021-Cert. Resolution approving Virginia Opioid MOU
3. DRAFT RESOLUTION (Feb 2023) for non-litigating cities and counties - Approval of Settlements with Teva Allergan Walmart CVS and Walgreens (002)

New National Opioids Settlements: Teva, Allergan, CVS, Walgreens, and Walmart
Opioids Implementation Administrator
opioidsparticipation@rubris.com

Charlottesville city, VA
Reference Number: CL-393057

TO LOCAL POLITICAL SUBDIVISIONS AND SPECIAL DISTRICTS:

THIS PACKAGE CONTAINS DOCUMENTATION TO PARTICIPATE IN THE NEW NATIONAL OPIOID SETTLEMENTS. YOU MUST TAKE ACTION IN ORDER TO PARTICIPATE.

Deadline: April 18, 2023

Five new proposed national opioid settlements ("*New National Opioid Settlements*") have been reached with **Teva, Allergan, CVS, Walgreens, and Walmart** ("*Settling Defendants*"). This *Participation Package* is a follow-up communication to the *Notice of National Opioid Settlements* recently received electronically by your subdivision or special district ("*subdivision*").

You are receiving this *Participation Package* because Virginia is participating in the following settlements:

- **Teva**
- **Allergan**
- **CVS**
- **Walgreens**
- **Walmart**

If a state does not participate in a particular Settlement, the subdivisions in that state are not eligible to participate in that Settlement.

This electronic envelope contains:

- *Participation Forms* for Teva, Allergan, CVS, Walgreens, and Walmart, including a release of any claims.

The *Participation Form* for each settlement must be executed, without alteration, and submitted on or before April 18, 2023, in order for your subdivision to be considered for initial participation calculations and payment eligibility.

Based upon subdivision participation forms received on or before April 18th, the subdivision participation rate will be used to determine whether participation for each deal is sufficient for the settlement to move forward and whether a state earns its maximum potential payment under the settlement. If the settlement moves forward, your release will become effective. If a settlement does not move forward, that release will not become effective.

Any subdivision that does not participate cannot directly share in the settlement funds, even if the subdivision's state is settling and other participating subdivisions are sharing in settlement funds. Any subdivision that does not participate may also reduce the amount of money for programs to remediate the opioid crisis in its state. Please note, a subdivision will not necessarily directly receive settlement funds by participating; decisions on how settlement funds will be allocated within a state are subject to intrastate agreements or state statutes.

In Virginia, participating counties and independent cities may receive some of the settlement funds directly, pursuant to the allocation framework set forth in the Virginia Opioid Abatement Fund and Settlement Allocation Memorandum of Understanding ("MOU"), which has been previously approved by all Virginia counties and cities, and the Virginia Opioid Abatement Fund statute, Va. Code § 2.2-2374. In addition, some towns are being asked to approve the settlements and submit participation forms because, due to the structure of the settlement agreements, towns above a certain population threshold must approve the settlements and submit participation forms in order to maximize the overall recovery for the Commonwealth and its subdivisions. Participating towns are not eligible to receive direct shares from the settlement funds—however, they may be able to apply for, request, or receive funds for opioid abatement programs through their counties. Participation by these towns will help to maximize the recovery for all of Virginia's counties, including the counties in which they are located.

You are encouraged to discuss the terms and benefits of the *New National Opioid Settlements* with your counsel, your Attorney General's Office, and other contacts within your state. Many states are implementing and allocating funds for these new settlements the same as they did for the prior opioid settlements with McKesson, Cardinal, Amerisource, and J&J/Janssen, but states may choose to treat these settlements differently.

Information and documents regarding the *New National Opioid Settlements* and how they are being implemented in your state and how funds will be allocated within your state allocation can be found on the national settlement website at <https://nationalopioidsettlement.com/>. This website will be supplemented as additional documents are created.

How to return signed forms:

There are three methods for returning the executed *Participation Forms* and any supporting documentation to the Implementation Administrator:

- (1) *Electronic Signature via DocuSign*: Executing the *Participation Forms* electronically through DocuSign will return the signed forms to the Implementation Administrator and associate your forms with your subdivision's records. Electronic signature is the most efficient method for returning *Participation Forms*, allowing for more timely participation and the potential to meet higher settlement payment thresholds, and is therefore strongly encouraged.

- (2) *Manual Signature returned via DocuSign*: DocuSign allows forms to be downloaded, signed manually, then uploaded to DocuSign and returned automatically to the Implementation Administrator. Please be sure to complete all fields. As with electronic signature, returning manually signed *Participation Forms* via DocuSign will associate your signed forms with your subdivision's records.
- (3) *Manual Signature returned via electronic mail*: If your subdivision is unable to return executed *Participation Forms* using DocuSign, signed *Participation Forms* may be returned via electronic mail to opioidsparticipation@rubris.com. Please include the name, state, and reference ID of your subdivision in the body of the email and use the subject line Settlement Participation Forms - [Subdivision Name, Subdivision State] - [Reference ID].

Detailed instructions on how to sign and return the *Participation Forms*, including changing the authorized signer, can be found at <https://nationalopioidsettlement.com>. You may also contact opioidsparticipation@rubris.com.

The sign-on period for subdivisions ends on April 18, 2023.

If you have any questions about executing these forms, please contact your counsel, the Implementation Administrator at opioidsparticipation@rubris.com, or Tom Beshere at the Virginia Attorney General's Office at 804-823-6335 or tbeshere@oag.state.va.us.

Thank you,

National Opioids Settlements Implementation Administrator

The Implementation Administrator is retained to provide the settlement notice required by the respective settlement agreements referenced above and to manage the collection of settlement participation forms for each settlement.

EXHIBIT K
Subdivision and Special District Settlement Participation Form

Will your subdivision or special district be signing the settlement participation forms for the Allergan and Teva Settlements at this time?

Yes No

Governmental Entity: Charlottesville city	State: VA
Authorized Signatory:	
Address 1:	
Address 2:	
City, State, Zip:	
Phone:	
Email:	

The governmental entity identified above (“*Governmental Entity*”), in order to obtain and in consideration for the benefits provided to the Governmental Entity pursuant to the Agreement dated November 22, 2022 (“*Allergan Settlement*”), and acting through the undersigned authorized official, hereby elects to participate in the Allergan Settlement, release all Released Claims against all Released Entities, and agrees as follows.

1. The Governmental Entity is aware of and has reviewed the Allergan Settlement, understands that all terms in this Election and Release have the meanings defined therein, and agrees that by this Election, the Governmental Entity elects to participate in the Allergan Settlement as provided therein.
2. Following the execution of this Settlement Participation Form, the Governmental Entity shall comply with Section III.B of the Allergan Settlement regarding Cessation of Litigation Activities.
3. The Governmental Entity shall, within fourteen (14) days of the Reference Date and prior to the filing of the Consent Judgment, file a request to dismiss with prejudice any Released Claims that it has filed. With respect to any Released Claims pending in *In re National Prescription Opiate Litigation*, MDL No. 2804, the Governmental Entity authorizes the MDL Plaintiffs’ Executive Committee to execute and file on behalf of the Governmental Entity a Stipulation of Dismissal With Prejudice substantially in the form found at <https://nationalopiodsettlement.com>.
4. The Governmental Entity agrees to the terms of the Allergan Settlement pertaining to Subdivisions and Special Districts as defined therein.
5. By agreeing to the terms of the Allergan Settlement and becoming a Releasor, the Governmental Entity is entitled to the benefits provided therein, including, if applicable, monetary payments beginning after the Effective Date.
6. The Governmental Entity agrees to use any monies it receives through the Allergan Settlement solely for the purposes provided therein.



7. The Governmental Entity submits to the jurisdiction of the court in the Governmental Entity's state where the Consent Judgment is filed for purposes limited to that court's role as provided in, and for resolving disputes to the extent provided in, the Allergan Settlement.
8. The Governmental Entity has the right to enforce the Allergan Settlement as provided therein.
9. The Governmental Entity, as a Participating Subdivision or Participating Special District, hereby becomes a Releasor for all purposes in the Allergan Settlement, including, but not limited to, all provisions of **Section V (Release)**, and along with all departments, agencies, divisions, boards, commissions, Subdivisions, districts, instrumentalities of any kind and attorneys, and any person in their official capacity whether elected or appointed to serve any of the foregoing and any agency, person, or other entity claiming by or through any of the foregoing, and any other entity identified in the definition of Releasor, provides for a release to the fullest extent of its authority. As a Releasor, the Governmental Entity hereby absolutely, unconditionally, and irrevocably covenants not to bring, file, or claim, or to cause, assist in bringing, or permit to be brought, filed, or claimed, or to otherwise seek to establish liability for any Released Claims against any Released Entity in any forum whatsoever. The releases provided for in the Allergan Settlement are intended to be broad and shall be interpreted so as to give the Released Entities the broadest possible bar against any liability relating in any way to Released Claims and extend to the full extent of the power of the Governmental Entity to release claims. The Allergan Settlement shall be a complete bar to any Released Claim.
10. The Governmental Entity hereby takes on all rights and obligations of a Participating Subdivision or Participating Special District as set forth in the Allergan Settlement.
11. In connection with the releases provided for in the Allergan Settlement, each Governmental Entity expressly waives, releases, and forever discharges any and all provisions, rights, and benefits conferred by any law of any state or territory of the United States or other jurisdiction, or principle of common law, which is similar, comparable, or equivalent to § 1542 of the California Civil Code, which reads:

General Release; extent. A general release does not extend to claims that the creditor or releasing party does not know or suspect to exist in his or her favor at the time of executing the release that, if known by him or her, would have materially affected his or her settlement with the debtor or released party.

A Releasor may hereafter discover facts other than or different from those which it knows, believes, or assumes to be true with respect to the Released Claims, but each Governmental Entity hereby expressly waives and fully, finally, and forever settles, releases and discharges, upon the Effective Date, any and all Released Claims that may exist as of such date but which Releasors do not know or suspect to exist, whether through ignorance, oversight, error, negligence or through no fault whatsoever, and which, if known, would materially affect the Governmental Entities' decision to participate in the Allergan Settlement.

12. Nothing herein is intended to modify in any way the terms of the Allergan Settlement, to which the Governmental Entity hereby agrees. To the extent this Settlement Participation Form is interpreted differently from the Allergan Settlement in any respect, the Allergan Settlement controls.



I have all necessary power and authorization to execute this Settlement Participation Form on behalf of the Governmental Entity.

Signature: _____

Name: _____

Title: _____

Date: _____



Exhibit K
Subdivision and Special District Settlement Participation Form

Governmental Entity: Charlottesville city	State: VA
Authorized Signatory:	
Address 1:	
Address 2:	
City, State, Zip:	
Phone:	
Email:	

The governmental entity identified above (“*Governmental Entity*”), in order to obtain and in consideration for the benefits provided to the Governmental Entity pursuant to the Agreement dated November 22, 2022 (“*Teva Settlement*”), and acting through the undersigned authorized official, hereby elects to participate in the Teva Settlement, release all Released Claims against all Released Entities, and agrees as follows.

1. The Governmental Entity is aware of and has reviewed the Teva Settlement, understands that all terms in this Election and Release have the meanings defined therein, and agrees that by this Election, the Governmental Entity elects to participate in the Teva Settlement as provided therein.
2. Following the execution of this Settlement Participation Form, the Governmental Entity shall comply with Section III.B of the Teva Settlement regarding Cessation of Litigation Activities.
3. The Governmental Entity shall, within 14 days of the Reference Date and prior to the filing of the Consent Judgment, file a request to dismiss with prejudice any Released Claims that it has filed. With respect to any Released Claims pending in In re National Prescription Opiate Litigation, MDL No. 2804, the Governmental Entity authorizes the Plaintiffs’ Executive Committee to execute and file on behalf of the Governmental Entity a Stipulation of Dismissal With Prejudice substantially in the form found at <https://nationalopioidsettlement.com>.
4. The Governmental Entity agrees to the terms of the Teva Settlement pertaining to Subdivisions as defined therein.
5. By agreeing to the terms of the Teva Settlement and becoming a Releasor, the Governmental Entity is entitled to the benefits provided therein, including, if applicable, monetary payments beginning after the Effective Date.
6. The Governmental Entity agrees to use any monies it receives through the Teva Settlement solely for the purposes provided therein.
7. The Governmental Entity submits to the jurisdiction of the court in the Governmental Entity’s state where the Consent Judgment is filed for purposes limited to that court’s role as provided in, and for resolving disputes to the extent provided in, the Teva Settlement.



8. The Governmental Entity has the right to enforce the Teva Settlement as provided therein.
9. The Governmental Entity, as a Participating Subdivision or Participating Special District, hereby becomes a Releasor for all purposes in the Teva Settlement, including but not limited to all provisions of Section V (Release), and along with all departments, agencies, divisions, boards, commissions, districts, instrumentalities of any kind and attorneys, and any person in their official capacity elected or appointed to serve any of the foregoing and any agency, person, or other entity claiming by or through any of the foregoing, and any other entity identified in the definition of Releasor, provides for a release to the fullest extent of its authority. As a Releasor, the Governmental Entity hereby absolutely, unconditionally, and irrevocably covenants not to bring, file, or claim, or to cause, assist or permit to be brought, filed, or claimed, or to otherwise seek to establish liability for any Released Claims against any Released Entity in any forum whatsoever. The releases provided for in the Teva Settlement are intended by Released Entities and the Governmental Entity to be broad and shall be interpreted so as to give the Released Entities the broadest possible bar against any liability relating in any way to Released Claims and extend to the full extent of the power of the Governmental Entity to release claims. The Teva Settlement shall be a complete bar to any Released Claim.
10. The Governmental Entity hereby takes on all rights and obligations of a Participating Subdivision or Participating Special District as set forth in the Teva Settlement.
11. In connection with the releases provided for in the Teva Settlement, each Governmental Entity expressly waives, releases, and forever discharges any and all provisions, rights, and benefits conferred by any law of any state or territory of the United States or other jurisdiction, or principle of common law, which is similar, comparable, or equivalent to § 1542 of the California Civil Code, which reads:

General Release; extent. A general release does not extend to claims that the creditor or releasing party does not know or suspect to exist in his or her favor at the time of executing the release that, if known by him or her, would have materially affected his or her settlement with the debtor or released party.

A Releasor may hereafter discover facts other than or different from those which it knows, believes, or assumes to be true with respect to the Released Claims, but each Governmental Entity hereby expressly waives and fully, finally, and forever settles, releases and discharges, upon the Effective Date, any and all Released Claims that may exist as of such date but which Releasors do not know or suspect to exist, whether through ignorance, oversight, error, negligence or through no fault whatsoever, and which, if known, would materially affect the Governmental Entities' decision to participate in the Teva Settlement.

12. Nothing herein is intended to modify in any way the terms of the Teva Settlement, to which Governmental Entity hereby agrees. To the extent this Election and Release is interpreted differently from the Teva Settlement in any respect, the Teva Settlement controls.



I have all necessary power and authorization to execute this Election and Release on behalf of the Governmental Entity.

Signature: _____

Name: _____

Title: _____

Date: _____



EXHIBIT K

Subdivision Participation and Release Form

Will your subdivision or special district be signing the settlement participation form for the CVS Settlement at this time?

Yes No

Governmental Entity: Charlottesville city	State: VA
Authorized Signatory:	
Address 1:	
Address 2:	
City, State, Zip:	
Phone:	
Email:	

The governmental entity identified above (“*Governmental Entity*”), in order to obtain and in consideration for the benefits provided to the Governmental Entity pursuant to the Settlement Agreement dated December 9, 2022 (“*CVS Settlement*”), and acting through the undersigned authorized official, hereby elects to participate in the CVS Settlement, release all Released Claims against all Released Entities, and agrees as follows.

1. The Governmental Entity is aware of and has reviewed the CVS Settlement, understands that all terms in this Participation and Release Form have the meanings defined therein, and agrees that by executing this Participation and Release Form, the Governmental Entity elects to participate in the CVS Settlement and become a Participating Subdivision as provided therein.
2. The Governmental Entity shall promptly, and in any event no later than 14 days after the Reference Date and prior to the filing of the Consent Judgment, dismiss with prejudice any Released Claims that it has filed. With respect to any Released Claims pending in *In re National Prescription Opiate Litigation*, MDL No. 2804, the Governmental Entity authorizes the Plaintiffs’ Executive Committee to execute and file on behalf of the Governmental Entity a Stipulation of Dismissal with Prejudice substantially in the form found at <https://nationalopioidsettlement.com>.
3. The Governmental Entity agrees to the terms of the CVS Settlement pertaining to Participating Subdivisions as defined therein.
4. By agreeing to the terms of the CVS Settlement and becoming a Releasor, the Governmental Entity is entitled to the benefits provided therein, including, if applicable, monetary payments beginning after the Effective Date.
5. The Governmental Entity agrees to use any monies it receives through the CVS Settlement solely for the purposes provided therein.



6. The Governmental Entity submits to the jurisdiction of the court in the Governmental Entity's state where the Consent Judgment is filed for purposes limited to that court's role as provided in, and for resolving disputes to the extent provided in, the CVS Settlement. The Governmental Entity likewise agrees to arbitrate before the National Arbitration Panel as provided in, and for resolving disputes to the extent otherwise provided in, the CVS Settlement.
7. The Governmental Entity has the right to enforce the CVS Settlement as provided therein.
8. The Governmental Entity, as a Participating Subdivision, hereby becomes a Releasor for all purposes in the CVS Settlement, including without limitation all provisions of Section XI (Release), and along with all departments, agencies, divisions, boards, commissions, districts, instrumentalities of any kind and attorneys, and any person in their official capacity elected or appointed to serve any of the foregoing and any agency, person, or other entity claiming by or through any of the foregoing, and any other entity identified in the definition of Releasor, provides for a release to the fullest extent of its authority. As a Releasor, the Governmental Entity hereby absolutely, unconditionally, and irrevocably covenants not to bring, file, or claim, or to cause, assist or permit to be brought, filed, or claimed, or to otherwise seek to establish liability for any Released Claims against any Released Entity in any forum whatsoever. The releases provided for in the CVS Settlement are intended by the Parties to be broad and shall be interpreted so as to give the Released Entities the broadest possible bar against any liability relating in any way to Released Claims and extend to the full extent of the power of the Governmental Entity to release claims. The CVS Settlement shall be a complete bar to any Released Claim.
9. The Governmental Entity hereby takes on all rights and obligations of a Participating Subdivision as set forth in the CVS Settlement.
10. In connection with the releases provided for in the CVS Settlement, each Governmental Entity expressly waives, releases, and forever discharges any and all provisions, rights, and benefits conferred by any law of any state or territory of the United States or other jurisdiction, or principle of common law, which is similar, comparable, or equivalent to § 1542 of the California Civil Code, which reads:

General Release; extent. A general release does not extend to claims that the creditor or releasing party does not know or suspect to exist in his or her favor at the time of executing the release that, if known by him or her would have materially affected his or her settlement with the debtor or released party.

A Releasor may hereafter discover facts other than or different from those which it knows, believes, or assumes to be true with respect to the Released Claims, but each Governmental Entity hereby expressly waives and fully, finally, and forever settles, releases and discharges, upon the Effective Date, any and all Released Claims that may exist as of such date but which Releasors do not know or suspect to exist, whether through ignorance, oversight, error, negligence or through no fault whatsoever, and which, if known, would materially affect the Governmental Entities' decision to participate in the CVS Settlement.



11. Nothing herein is intended to modify in any way the terms of the CVS Settlement, to which Governmental Entity hereby agrees. To the extent this Participation and Release Form is interpreted differently from the CVS Settlement in any respect, the CVS Settlement controls.

I have all necessary power and authorization to execute this Participation and Release Form on behalf of the Governmental Entity.

Signature: _____

Name: _____

Title: _____

Date: _____



EXHIBIT K

Subdivision Participation and Release Form

Will your subdivision or special district be signing the settlement participation form for the Walgreens Settlement at this time?

Yes No

Governmental Entity: Charlottesville city	State: VA
Authorized Signatory:	
Address 1:	
Address 2:	
City, State, Zip:	
Phone:	
Email:	

The governmental entity identified above (“*Governmental Entity*”), in order to obtain and in consideration for the benefits provided to the Governmental Entity pursuant to the Settlement Agreement dated December 9, 2022 (“*Walgreens Settlement*”), and acting through the undersigned authorized official, hereby elects to participate in the Walgreens Settlement, release all Released Claims against all Released Entities, and agrees as follows.

1. The Governmental Entity is aware of and has reviewed the Walgreens Settlement, understands that all terms in this Participation and Release Form have the meanings defined therein, and agrees that by executing this Participation and Release Form, the Governmental Entity elects to participate in the Walgreens Settlement and become a Participating Subdivision as provided therein.
2. The Governmental Entity shall promptly, and in any event no later than 14 days after the Reference Date and prior to the filing of the Consent Judgment, dismiss with prejudice any Released Claims that it has filed. With respect to any Released Claims pending in *In re National Prescription Opiate Litigation*, MDL No. 2804, the Governmental Entity authorizes the Plaintiffs’ Executive Committee to execute and file on behalf of the Governmental Entity a Stipulation of Dismissal with Prejudice substantially in the form found at <https://nationalopioidsettlement.com>.
3. The Governmental Entity agrees to the terms of the Walgreens Settlement pertaining to Participating Subdivisions as defined therein.
4. By agreeing to the terms of the Walgreens Settlement and becoming a Releasor, the Governmental Entity is entitled to the benefits provided therein, including, if applicable, monetary payments beginning after the Effective Date.
5. The Governmental Entity agrees to use any monies it receives through the Walgreens Settlement solely for the purposes provided therein.



6. The Governmental Entity submits to the jurisdiction of the court in the Governmental Entity's state where the Consent Judgment is filed for purposes limited to that court's role as provided in, and for resolving disputes to the extent provided in, the Walgreens Settlement. The Governmental Entity likewise agrees to arbitrate before the National Arbitration Panel as provided in, and for resolving disputes to the extent otherwise provided in, the Walgreens Settlement.
7. The Governmental Entity has the right to enforce the Walgreens Settlement as provided therein.
8. The Governmental Entity, as a Participating Subdivision, hereby becomes a Releasor for all purposes in the Walgreens Settlement, including without limitation all provisions of Section XI (Release), and along with all departments, agencies, divisions, boards, commissions, districts, instrumentalities of any kind and attorneys, and any person in their official capacity elected or appointed to serve any of the foregoing and any agency, person, or other entity claiming by or through any of the foregoing, and any other entity identified in the definition of Releasor, provides for a release to the fullest extent of its authority. As a Releasor, the Governmental Entity hereby absolutely, unconditionally, and irrevocably covenants not to bring, file, or claim, or to cause, assist or permit to be brought, filed, or claimed, or to otherwise seek to establish liability for any Released Claims against any Released Entity in any forum whatsoever. The releases provided for in the Walgreens Settlement are intended by the Parties to be broad and shall be interpreted so as to give the Released Entities the broadest possible bar against any liability relating in any way to Released Claims and extend to the full extent of the power of the Governmental Entity to release claims. The Walgreens Settlement shall be a complete bar to any Released Claim.
9. The Governmental Entity hereby takes on all rights and obligations of a Participating Subdivision as set forth in the Walgreens Settlement.
10. In connection with the releases provided for in the Walgreens Settlement, each Governmental Entity expressly waives, releases, and forever discharges any and all provisions, rights, and benefits conferred by any law of any state or territory of the United States or other jurisdiction, or principle of common law, which is similar, comparable, or equivalent to § 1542 of the California Civil Code, which reads:

General Release; extent. A general release does not extend to claims that the creditor or releasing party does not know or suspect to exist in his or her favor at the time of executing the release that, if known by him or her would have materially affected his or her settlement with the debtor or released party.

A Releasor may hereafter discover facts other than or different from those which it knows, believes, or assumes to be true with respect to the Released Claims, but each Governmental Entity hereby expressly waives and fully, finally, and forever settles, releases and discharges, upon the Effective Date, any and all Released Claims that may exist as of such date but which Releasors do not know or suspect to exist, whether through ignorance, oversight, error, negligence or through no fault whatsoever, and which, if known, would materially affect the Governmental Entities' decision to participate in the Walgreens Settlement.



11. Nothing herein is intended to modify in any way the terms of the Walgreens Settlement, to which Governmental Entity hereby agrees. To the extent this Participation and Release Form is interpreted differently from the Walgreens Settlement in any respect, the Walgreens Settlement controls.

I have all necessary power and authorization to execute this Participation and Release Form on behalf of the Governmental Entity.

Signature: _____

Name: _____

Title: _____

Date: _____



EXHIBIT K

Subdivision Participation Form

Will your subdivision or special district be signing the settlement participation form for the Walmart Settlement at this time?

Yes No

Governmental Entity: Charlottesville city	State: VA
Authorized Official:	
Address 1:	
Address 2:	
City, State, Zip:	
Phone:	
Email:	

The governmental entity identified above (“Governmental Entity”), in order to obtain and in consideration for the benefits provided to the Governmental Entity pursuant to the Settlement Agreement dated November 14, 2022 (“Walmart Settlement”), and acting through the undersigned authorized official, hereby elects to participate in the Walmart Settlement, release all Released Claims against all Released Entities, and agrees as follows.

1. The Governmental Entity is aware of and has reviewed the Walmart Settlement, understands that all terms in this Election and Release have the meanings defined therein, and agrees that by this Election, the Governmental Entity elects to participate in the Walmart Settlement and become a Participating Subdivision as provided therein.
2. The Governmental Entity shall promptly, and in any event within 14 days of the Effective Date and prior to the filing of the Consent Judgment, dismiss with prejudice any Released Claims that it has filed. With respect to any Released Claims pending in In re National Prescription Opiate Litigation, MDL No. 2804, the Governmental Entity authorizes the Plaintiffs’ Executive Committee to execute and file on behalf of the Governmental Entity a Stipulation of Dismissal With Prejudice substantially in the form found at <https://nationalopioidsettlement.com/>.
3. The Governmental Entity agrees to the terms of the Walmart Settlement pertaining to Subdivisions as defined therein.
4. By agreeing to the terms of the Walmart Settlement and becoming a Releasor, the Governmental Entity is entitled to the benefits provided therein, including, if applicable, monetary payments beginning after the Effective Date.
5. The Governmental Entity agrees to use any monies it receives through the Walmart Settlement solely for the purposes provided therein.



6. The Governmental Entity submits to the jurisdiction of the court in the Governmental Entity's state where the Consent Judgment is filed for purposes limited to that court's role as provided in, and for resolving disputes to the extent provided in, the Walmart Settlement.
7. The Governmental Entity has the right to enforce the Walmart Settlement as provided therein.
8. The Governmental Entity, as a Participating Subdivision, hereby becomes a Releasor for all purposes in the Walmart Settlement, including but not limited to all provisions of Section X (Release), and along with all departments, agencies, divisions, boards, commissions, districts, instrumentalities of any kind and attorneys, and any person in their official capacity elected or appointed to serve any of the foregoing and any agency, person, or other entity claiming by or through any of the foregoing, and any other entity identified in the definition of Releasor, provides for a release to the fullest extent of its authority. As a Releasor, the Governmental Entity hereby absolutely, unconditionally, and irrevocably covenants not to bring, file, or claim, or to cause, assist or permit to be brought, filed, or claimed, or to otherwise seek to establish liability for any Released Claims against any Released Entity in any forum whatsoever. The releases provided for in the Walmart Settlement are intended by the Parties to be broad and shall be interpreted so as to give the Released Entities the broadest possible bar against any liability relating in any way to Released Claims and extend to the full extent of the power of the Governmental Entity to release claims. The Walmart Settlement shall be a complete bar to any Released Claim.
9. In connection with the releases provided for in the Walmart Settlement, each Governmental Entity expressly waives, releases, and forever discharges any and all provisions, rights, and benefits conferred by any law of any state or territory of the United States or other jurisdiction, or principle of common law, which is similar, comparable, or equivalent to § 1542 of the California Civil Code, which reads:

General Release; extent. A general release does not extend to claims that the creditor or releasing party does not know or suspect to exist in his or her favor at the time of executing the release that, if known by him or her, would have materially affected his or her settlement with the debtor or released party.

A Releasor may hereafter discover facts other than or different from those which it knows, believes, or assumes to be true with respect to the Released Claims, but each Governmental Entity hereby expressly waives and fully, finally, and forever settles, releases and discharges, upon the Effective Date, any and all Released Claims that may exist as of such date but which Releasors do not know or suspect to exist, whether through ignorance, oversight, error, negligence or through no fault whatsoever, and which, if known, would materially affect the Governmental Entities' decision to participate in the Walmart Settlement.

10. Nothing herein is intended to modify in any way the terms of the Walmart Settlement, to which Governmental Entity hereby agrees. To the extent this Election and Release is interpreted differently from the Walmart Settlement in any respect, the Walmart Settlement controls.



I have all necessary power and authorization to execute this Election and Release on behalf of the Governmental Entity.

Signature: _____

Name: _____

Title: _____

Date: _____



**RESOLUTION
APPROVING PARTICIPATION BY THE CITY OF CHARLOTTESVILLE IN THE
VIRGINIA OPIOID ABATEMENT FUND AND APPROVING THE CITY’S
EXECUTION OF THE VIRGINIA SETTLEMENT ALLOCATION MEMORANDUM
OF UNDERSTANDING**

WHEREAS, the opioid epidemic that has cost thousands of human lives across the country also impacts the Commonwealth of Virginia and its cities and counties by adversely impacting, amongst other things, the delivery of emergency medical, law enforcement, criminal justice, mental health and substance abuse services, and other services; and

WHEREAS, the Commonwealth of Virginia and its cities and counties have been required and will continue to be required to allocate substantial taxpayer dollars, resources, staff energy and time to address the damage the opioid epidemic has caused and continues to cause the citizens of Virginia; and

WHEREAS, in order to advance their common interests, Virginia local governments and the Commonwealth of Virginia, through counsel, have extensively negotiated the terms of a memorandum of understanding relating to the allocation and use of litigation recoveries relating to the opioid epidemic (“Virginia Opioid Abatement Fund and Settlement Allocation Memorandum of Understanding” or “MOU”) and the Council’s approval of the MOU will allow the City to participate in and receive proceeds from the opioid settlements.

NOW, THEREFORE, BE IT RESOLVED by the Council of the City of Charlottesville that the City’s participation in the Commonwealth of Virginia’s Opioid Abatement Fund and Settlement Allocation Memorandum of Understanding is approved, and the City Manager is hereby authorized to execute the MOU on behalf of the City. The City Manager and City Attorney are each hereby authorized by this Council to execute, on behalf of the City of Charlottesville and this Council, any other or additional documents that may be necessary to effectuate the City’s participation in the MOU.

I, Kyna Thomas, do hereby certify that the foregoing writing is a true, correct copy of a resolution duly adopted by the City Council of the City of Charlottesville, Virginia, by a vote of 4 to 0 , as recorded below, at a regular meeting held on December 06, 2021.

	<u>Aye</u>	<u>No</u>
Mayor Walker	<u> x </u>	<u> </u>
Vice Mayor Magill	<u>(absent)</u>	<u> </u>
Councilor Hill	<u> x </u>	<u> </u>
Councilor Payne	<u> x </u>	<u> </u>
Councilor Snook	<u> x </u>	<u> </u>

RESOLUTION

A RESOLUTION OF THE CHARLOTTESVILLE CITY COUNCIL APPROVING OF THE CITY'S PARTICIPATION IN THE PROPOSED SETTLEMENT OF OPIOID-RELATED CLAIMS AGAINST TEVA, ALLERGAN, WALMART, WALGREENS, CVS, AND THEIR RELATED CORPORATE ENTITIES, AND DIRECTING THE CITY MANAGER AND THE CITY ATTORNEY TO EXECUTE THE DOCUMENTS NECESSARY TO EFFECTUATE THE CITY'S PARTICIPATION IN THE SETTLEMENTS

WHEREAS, the opioid epidemic that has cost thousands of human lives across the country also impacts the Commonwealth of Virginia and its counties and cities, including the City of Charlottesville, by adversely impacting the delivery of emergency medical, law enforcement, criminal justice, mental health and substance abuse services, and other services by the City of Charlottesville's various departments and agencies; and

WHEREAS, the Commonwealth of Virginia and its counties and cities, including the City of Charlottesville, have been required and will continue to be required to allocate substantial taxpayer dollars, resources, staff energy and time to address the damage the opioid epidemic has caused and continues to cause the citizens of the Commonwealth and the City; and

WHEREAS, settlement proposals have been negotiated that will cause Teva, Allergan, Walmart, Walgreens, and CVS to pay billions of dollars nationwide to resolve opioid-related claims against them; and

WHEREAS, the City has approved and adopted the Virginia Opioid Abatement Fund and Settlement Allocation Memorandum of Understanding (the "Virginia MOU") by resolution dated December 6, 2021, and affirms that these pending settlements with Teva, Allergan, Walmart, CVS, and Walgreens shall be considered "Settlements" that are subject to the Virginia MOU, and shall be administered and allocated in the same manner as the opioid settlements entered into previously with opioid distributors McKesson, Cardinal Health, and AmerisourceBergen, and opioid manufacturer Janssen Pharmaceuticals;

WHEREAS, the City Manager's Office requests the authority to execute the attached Participation Agreement and to participate in the proposed settlements in order to recover the City's share of the funds that such settlement would provide; and

WHEREAS, the City Attorney's Office has reviewed the available information about the proposed settlements and the attached Participation Agreement and has approved such documents as to form and recommends that the City can participate in the settlements in order to recover its share of the funds that the settlement would provide.

NOW THEREFORE BE IT RESOLVED that the Charlottesville City Council, this ____ day of _____, 2023, hereby authorizes the City Manager to execute the attached Participation Forms and approves of the City's participation in the proposed settlement of opioid-related claims against Teva, Allergan, Walmart, Walgreens, CVS, and their related corporate entities, and directs the City Manager and the City Attorney to execute the documents necessary

to effectuate the City's participation in the settlements, including the required release of claims against settling entities.

CITY OF CHARLOTTESVILLE, VIRGINIA
CITY COUNCIL AGENDA



Agenda Date:	March 20, 2023
Action Required:	Motion to Approve a Certificate of Appropriateness, or Motion to Deny a Certificate of Appropriateness
Presenter:	Jeffrey Werner, Historic Preservation and Design Planner
Staff Contacts:	Jeffrey Werner, Historic Preservation and Design Planner
Title:	Appeal of BAR (Board of Architectural Review) denial of Certificate of Appropriateness: First United Methodist Church solar panel project

Background

- On January 18, 2023, the City's Board of Architectural Review denied a certificate of appropriateness (CoA) for installation of rooftop photovoltaic/solar panels at 101 East Jefferson Street, pursuant to the details set forth within City application BAR 22-10-02. [See the Discussion below re: BAR's formal denial] [Note: Link to January 18, 2023 BAR action, staff report, submittal, and historical survey: [BAR meeting packet - 101 E Jefferson St - Jan 18 2023](#)]
- The owner of 101 East Jefferson Street on January 30, 2023, appealed the BAR's decision to City Council, pursuant to City Code §34-285(b) ("any aggrieved person may note an appeal of the BAR decision to the city council"). [Attachment 1.]
- State enabling legislation authorizes the City to establish historic districts within its zoning ordinance, and to designate specific buildings or structures within the zoning ordinance as having important historic, architectural, archaeological or cultural interest. Va. Code §15.2-2306(A)(1). Within the City's zoning ordinance, 101 East Jefferson Street is located within the North Downtown ADC District. City Code §34-272(2). (The structures at 101 East Jefferson Street are designated *contributing*, which identifies structures deemed to *contribute to* the character of an ADC District. City Code §34-277.)
- State law also authorizes the City to include within its ordinance a requirement that no building or structure, including signs, shall be erected, reconstructed, altered or restored within any such district unless approved by the review board or, on appeal, by the governing body of the locality as being architecturally compatible with the historic landmarks, buildings or structures therein. Va. Code §15.2-2306(A)(1). This is implemented in the City's zoning ordinance by City Code Chapter 34 – Zoning, Article II - Overlay Districts, Division 2 - Historical Preservation and Architectural Design Control Overlay Districts.

- State law also requires the City, by enacting the above, include within its ordinance the right of the owner of a historic landmark, building or structure to appeal to the circuit court for such locality from any final decision of the governing body. Va. Code §15.2-2306(A)(3). This is implemented in the City’s zoning ordinance by City Code §§ 34-285 and 34-286.
- **The City Council’s role in this appeal is to make the final decision of the governing body on the certificate of appropriateness (i.e., approval or denial).** According to City Code §34-286(b): “City Council shall consult with the BAR and consider the written appeal, the criteria [*standards for review*] set forth within section 34-276 or 34-278, as applicable, and any other information, factors, or opinions it deems relevant to the application.” Council should make a final decision on the application, and should not refer the matter back to the BAR.

[Staff note: Sec. 34-276, applicable here, proscribes the *standards for review of construction and alterations*. Sec. 34-278 proscribes the *standards for considering demolitions*.]

Sample motion to approve: “Upon consideration of all of the information and factors referenced in City Code §34-276 and 34-286, I move to approve a certificate of appropriateness for Application No. BAR 22-10-02.”

Sample motion to deny: “Upon consideration of all of the information and factors referenced in City Code §34-276 and 34-286, I move to deny a certificate of appropriateness for Application No. BAR 21-10-02.”

- If the owner of 101 East Jefferson Street is aggrieved by City Council’s final decision, the owner may appeal the decision to the Charlottesville Circuit Court. The City’s ordinance does not allow appeals to Circuit Court by anyone other than the landowner. City Code §34-286(c). [See below under *Alternatives*.]

The order of presentation for Council’s review of an appeal from a BAR decision is: (1) City Preservation and Design Planner presentation of the staff report (ten minutes), (2) Appellants’ presentation (ten minutes), and (3) BAR chair presentation (five minutes).

Discussion

Constructed in 1923, First United Methodist Church is a Colonial Revival, brick church with a monumental portico on the south elevation featuring four Doric columns and a three-story brick tower with a wood-framed steeple on the east elevation. The parcel is within the North Downtown ADC District and the structures are designated as *contributing*.

From Chapter I of the ADC District Design Guidelines:

North Downtown ADC District: Adjacent to the Albemarle County Courthouse and laid out according to the 1762 town grid, this area served as the city’s first civic, religious, and commercial center. Thomas Jefferson, James Monroe and James Madison were frequent visitors to the Court Square area. Park Street residences built in the late eighteenth century for lawyers, judges and other professionals still retain their architectural integrity. Today, this district represents the socio-economic and architectural evolution of the original town.

Subarea b. Jefferson Street/High Street West: institutional, residential, large scale, open space, brick,

2 to 5 stories, limited setbacks, mix of styles, some classical styles.

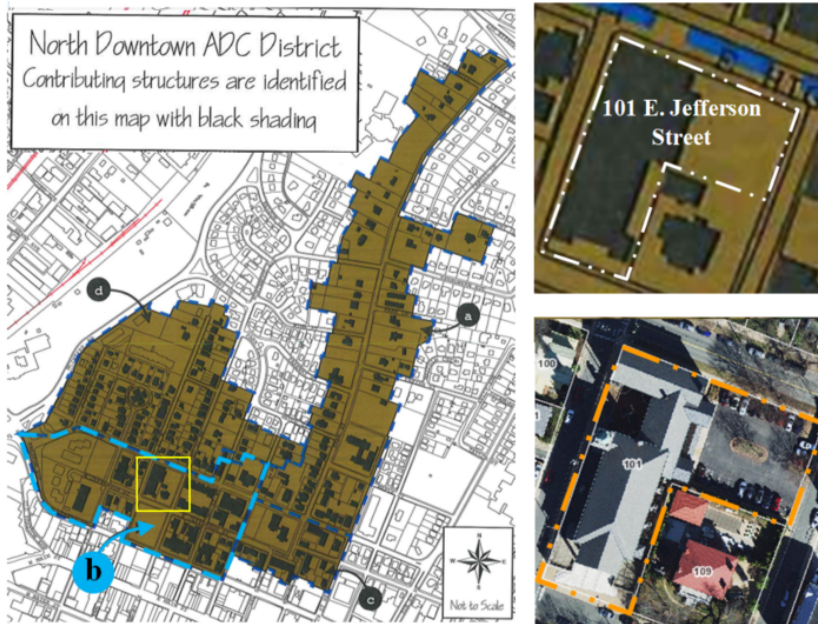

In August 2022, the church inquired about installing solar panels and the BAR review process. (See Attachment 5.)

During the September 20, 2022 BAR meeting, staff informally introduced the request, with the BAR offering the following, which staff subsequently communicated to the church.

1. BAR questions for the applicant.
 - How will the panels be installed/mounted? (Brackets, hardware, etc.)
 - Where will wires/cables/conduit and equipment boxes be placed and how will they be screened, if necessary?
 - How high will the panels be above the slate?
 - How will the slate roof be protected during installation and subsequent maintenance of the solar panels? (Concern for condition of slate tiles with more-frequent activity.)
 - Photo-sim: panels on sanctuary are oriented NW.
2. BAR comments to the applicant.
 - Preference: install panels on rear addition; avoid panels on sanctuary.
 - Re: maximizing panel area, a frame over the parking area (east side) might be evaluated.

Meeting video (04:41:00): [BAR Meeting Video Sept 20 2022](#)

At the October 18, 2022 BAR meeting, a formal CoA request to install solar panels on the existing slate roof was presented (BAR #22-10-02). A motion to approve the CoA failed, 2-4. The applicant then requested, and the BAR accepted, a request for deferral.

Meeting video (02:06:00): [BAR Meeting Video Oct 18 2022](#)

Meeting packet: [101 East Jefferson Street - BAR Submittal Oct 2022](#)

At the January 18, 2023 BAR meeting, a formal CoA request to remove portions of the slate roof,

install asphalt shingles, and install solar panels was presented (BAR #22-10-02). A motion to deny the CoA passed 4-3. (Motion to deny CoA by Lewis. Second by Schwarz. Vote 4-3, motion passed. Yes: Schwarz, Zehmer, Lewis, Bailey. No: Birle, Gastinger, Timmerman.)

Having considered the standards set forth within the City Code, including the ADC District Design Guidelines, I move to find that the proposed slate roof replacement and roof-top solar panels at 101 East Jefferson Street do not satisfy the BAR's criteria and are not compatible with this property and the other properties in the North Downtown ADC District for the following reasons:

- the removal of the slate and obscuring and damaging the slate does not meet our guidelines;
- this proposed system of rooftop installation does not comply with the Secretary of Interior standards;

and the BAR denies the application as submitted.

Meeting video (01:06:00): [BAR meeting video - January 18 2023](#)

Meeting packet: [BAR meeting packet - 101 E Jefferson St - Jan 18 2023.](#)

During the BAR's discussions—informal and formal—three primary questions were weighed:

1. How much damage will be done to the slate during installation and subsequent maintenance of the solar panels, and how will that be mitigated?
2. Per the proscribed standards for review, is the installation of solar panels appropriate at the proposed location?
3. Per the proscribed standards for review, is removal of the slate [entirely or partially] and replacement with asphalt shingles appropriate?

For the final submittal (reviewed January 18, 2023), the applicant addressed the first question by proposing removal of the slate and the installation of asphalt shingles at areas where the solar panels will be installed.

For the second question, the ADC District Design Guidelines (Chapter IV – Rehabilitation. G. Roof) recommend solar collectors be installed on *non-character defining roofs or roofs of non-historic adjacent buildings*. Additionally, *The Secretary of the Interior's Standards for Rehabilitation (Secretary's Standards)* offer ten criteria for evaluating rooftop solar panels. When applied to this request, the germane criteria did not support approval. (See pages 5 – 8 of the January 18, 2023 BAR staff report.)

For the third question--and to the BAR, the most important question--the ADC District Design Guidelines (Chapter IV – *Rehabilitation. G. Roof*) recommend that *when replacing a roof, match original materials as closely as possible and to retain elements that contribute to the style and character of the building*. In brief, to preserve the historic, character-defining slate roof.

Additionally, slate is a long-life, durable product. Properly maintained, a Buckingham slate roof can exceed 150 years. (The roof is Buckingham slate, believed to be original to the 1923 construction.) Absent the installation of solar panels, there is no demonstrated need to remove and replace the slate.

Regarding the apparent conflict of the BAR's standards of review and the City's broader policy goals and initiatives, this is acknowledged in the January 18, 2023, staff report, with staff offering the BAR the following recommendation:

To be clear, a strict application of the design guidelines and of the Secretary's Standards would recommend denial of this request. With that, the options available to the BAR are: a) approve the CoA by, as instructed by the design guidelines, working with the applicant to devise a creative solution that meets that applicant's goal for sustainability; or, b) deny the CoA, acknowledging the matter can be appealed to City Council who may consider additional information, factors or opinions deem[ed] relevant to the [appeal]. (That is, Council may consider factors the BAR cannot.)

(For a more detailed summary, see Attachment 2: Staff response to appeal.)

Attachments: [Note: link to the January 18, 2023 BAR staff report and applicant submittal: [BAR meeting packet - 101 E Jefferson St - Jan 18 2023.](#)]

1. January 30, 2023, First United Methodist Church letter appealing BAR's January 18, 2023 action re: BAR 22-10-03.
2. Staff response to appeal.
3. BAR meeting draft minutes, October 18, 2022. Excerpts re: FUMC, including action taken.
4. BAR meeting draft minutes, January 18, 2023. Excerpts re: FUMC, including action taken.
5. Misc. email correspondence with applicant August 31 to December 14, 2022.

Appendix

Links to the City of Charlottesville's ADC District Design Guidelines

- [Chapter 1 Introduction \(Part 1\)](#)
- [Chapter 1 Introduction \(Part 2\)](#)
- [Chapter 2 Site Design and Elements](#)
- [Chapter 3 New Construction and Additions](#)
- [Chapter 4 Rehabilitation](#)
- [Chapter 5 Signs, Awnings, Vending, and Cafes](#)
- [VII: Public Improvements](#)
- [Chapter 7 Moving and Demolition](#)
- [Index](#)

Alignment with City Council's Vision and Strategic Plan

Upholding the BAR's decision aligns with Council's vision for Charlottesville Arts and Culture: Charlottesville cherishes and builds programming around the evolving research and interpretation of our historic heritage and resources; and for A Green City: Charlottesville citizens live in a community with a vibrant urban forest, tree-lined streets, and lush green neighborhoods. It contributes to Goal 2 of the Strategic Plan, to be a safe, equitable, thriving and beautiful community, and objective 2.5, to provide natural and historic resources stewardship.

Community Engagement

City Code Sec. 34-284 requires public notice prior to the BAR's formal review of a CoA request. For the BAR meetings on October 18, 2022, and January 18, 2023, the abutting landowners were notified by letter and the meeting was publicly posted.

Except for the applicant and individuals with the project team, there were no public comments offered during the October 18, 2022 and January 18, 2023 meetings. [See minutes in Attachments 3 and 4.]

Note: Minutes for October 18, 2022 and January 18, 2023 meetings have not been approved by the BAR. The draft minutes reflect only the BAR's discussion and comments prior to action taken.

Budgetary Impact

None

Recommendation

Based on the application materials, the information and standards set forth within City Code §34-276 and §34-286, and for the reasons set forth within this memo, the applicant's appeal, the staff response to that appeal (Attachment 2 of this memo), and the January 18, 2023, BAR staff report (link above), staff's recommendation is that City Council render a final decision regarding this CoA, and not refer the matter back to the BAR.

Alternatives

1. If City Council agrees with the appellant, then Council should vote to overturn the BAR decision, approving the CoA allowing replacement of the slate with asphalt shingles and installation of the rooftop solar panels, as proposed under BAR #22-102.
2. If City Council agrees with the BAR decision to deny the CoA, then Council should vote to uphold the decision. The applicant would then have the option, per Sec. 34-286(c), to make further appeal to the Circuit Court.

Sec. 34-286. - City council appeals.

1. An applicant shall set forth, in writing, the grounds for an appeal, including the procedure(s) or standard(s) alleged to have been violated or misapplied by the BAR, and/or any additional information, factors or opinions he or she deems relevant to the application. The applicant, or his agent, and any aggrieved person, shall be given an opportunity to be heard on the appeal.
2. In any appeal the city council shall consult with the BAR and consider the written appeal, the criteria set forth within section 34-276 or 34-278, as applicable, and any other information, factors, or opinions it deems relevant to the application.
3. A final decision of the city council may be appealed by the owner of the subject property to the Circuit Court for the City of Charlottesville, by filing with the court a petition at law, setting forth the alleged illegality of the action taken. such petition must be filed with the circuit court within thirty (30) days after council's final decision. The filing of the petition shall stay the council's decision pending the outcome of the appeal; except that the filing of the petition shall not stay a decision of city council denying permission to demolish a building or structure. Any appeal which may be taken to the circuit court from a decision of the city council to deny a permit for

the demolition of a building or structure shall not affect the right of the property owner to make the bona fide offer to sell referred to in subparagraphs (d) and (e), below.

Attachments

1. Attachment 1 - FUMC appeal of BAR denial - Rooftop Solar Panels January 30 2023-
2. Attachment 2 - FUMC appeal - BAR staff response
3. Attachment 3 -FUMC -BAR meeting minutes October 18 2022
4. Attachment 4 -FUMC - BAR meeting minutes January 18 2023
5. Attachment 5 -FUMC -Misc email FUMC solar panels Aug 31 - Dec 14 2022



FIRST

UNITED METHODIST CHURCH

101 E. Jefferson St., Charlottesville, VA 22902

office@cvillefirstumc.org

January 30, 2023

Kyna Thomas
Chief of Staff/Clerk of Council
City of Charlottesville
City Hall | P.O. Box 911
Charlottesville, VA 22902

RE: Certificate of Appropriateness BAR # 22-10-02

Dear Ms. Thomas:

With this letter, the leadership and congregation of First United Methodist Church (FUMC) ask for an appeal of the Board of Architectural Review’s denial of a Certificate of Appropriateness to install rooftop solar panels (BAR # 22-10-02). We feel the BAR’s vote was based on out-of-date Architectural Design Control Districts Guidelines that are now in conflict and incongruous with the current vision and goals of the City of Charlottesville to promote the use of sustainable energy.

The ADC District Guidelines were last revised in September 17, 2012 and, as admitted by the BAR during our meeting on January 18, 2023, are in need of updating, particularly in regard to renewable energy and specifically solar panels. Since the guidelines’ last revision, the City has approved numerous statements, standards, plans, amendments and initiatives to not only support and encourage sustainable energy, but also to make it a matter of governing policy. Below we note a partial list of some of those documents with key supporting passages:

- City Council Vision Statement 2025 which describes the vision for Charlottesville to be A Green City – “Charlottesville citizens live in a community with a vibrant urban forest, tree-lined streets, and lush green neighborhoods. We have an extensive natural trail system, along with healthy rivers and streams. We have clean air and water, we emphasize recycling and reuse, and we minimize stormwater runoff. *Our homes and buildings are sustainably designed and energy efficient.*”
- Solarize Charlottesville campaign, 2014-present, managed by LEAP and supported by the City in partnership with the City’s Climate Protection Program, “a community-based outreach initiative that *reduces the cost and complexity of going solar* by providing a one-stop shop for education and installation.”

- Charlottesville Standards & Design Manual revised in 2019 to include Chapter 7 Environmental Sustainability. Section 7.2 makes multiple references to the inclusion of solar power including:
 - 7.2.2 Energy Optimization – “...the following comprehensive, integrated approach should be applied during a building's design and development as well as during the *reuse, renovation, or repair of existing buildings*: Employ renewable energy sources such as solar heating for hot water, *photovoltaics*, geothermal space heating, and groundwater cooling, sized for the reduced building loads.”
 - 7.2.3 Clean Energy, Renewable Energy – “There is great potential for *solar power generation* in Charlottesville.”
- City of Charlottesville Strategic Plan, adopted in 2017 and extended through 2021, includes as Goal 3: A Beautiful and Sustainable Natural and Built Environment. Objective 3.4: Be Responsible Stewards of Natural Resources includes under the Measure: Solar Energy Installation Capacity - “The City of Charlottesville supports increases in renewable sources for energy generation. *Solar energy is one technology particularly suitable to Charlottesville.*”
- Comprehensive Plan, adopted by City Council on November 15, 2021, has as Chapter 7 Environment, Climate and Food Equity a Community Vision Statement that includes “The City, *with the cooperation with the Charlottesville community*, will both mitigate and prepare for the potential impacts of climate change *by increasing reliable access to and use of clean energy sources*, improving building energy performance, pursuing resilience and adaptation strategies, promoting sustainable waste management, and utilizing food & climate equity approaches.” Goals and Strategies of Goal 1: Climate Change, Mitigation, Emissions and Energy include:
 - Strategy 1.1, Sub-strategies:
 - “The City government should lead by example on implementing emissions reduction strategies.”
 - “Support action within key community sectors (residential, commercial, and transportation) through policy, education, and program strategies.”
 - Strategy 1.3 – “Improve energy performance of *existing* and new *buildings community-wide through City policy standards* and leveraging local partner resources.”
 - Strategy 1.5 – “Pursue use of cleaner sources of energy (e.g., renewable energy strategies) community-wide.”
- Most importantly, the Charlottesville Climate Action Plan, completed in November 2022 and just formally adopted as an amendment to the City’s Comprehensive Plan on January 17, 2023. While the 98-page document is completely dedicated to “... specific strategies and key actions for Charlottesville to reduce its greenhouse gas emissions in alignment with its reduction goals,” just a few of its germane passages are:
 - Chapter 3 – Charlottesville GHG Emissions and Targets, Example Reduction Scenarios: “In considering emissions reductions in our buildings, these scenarios considered improving the energy efficiency of existing buildings, *adding onsite rooftop solar energy systems*, and the expected emissions reduction from electricity supplied by Dominion Power.”
 - Chapter 4 – Guides for Action, Climate Action Fact Sheets: Fact Sheet 4 – Onsite Renewables, *Solar*.

- Chapter 5 – Strategies and Actions: Community:
 - Building and Energy, Electricity: “Charlottesville can further its transition to carbon-free electricity and more greatly frontload its reductions by installing renewable energy systems onsite. *Solar energy systems have been increasing in number through programs such as Solarize Charlottesville and with support by Charlottesville’s Clean Energy Loan Fund for commercial and non-profit organizations.*”
 - Equity Considerations, Sub-Goals: “Renewable Energy: *Aim for 10% of Charlottesville’s rooftop solar potential to be installed by 2030.*”
 - Strategies and Key Actions: “Strategy: *Increase energy efficiency and onsite renewable energy use in existing buildings.*”

Additional examples and references to the City’s website could be included, but it seems clear that in the ten years since the ADC District Guidelines were last updated the City has dramatically increased its support of sustainable energy. The City’s website Renewable Energy: Solar page even highlights FUMC on its Charlottesville Solar: Rooftop Potential map. And while the ADC District Guidelines state that “Sustainability and preservation are complementary concepts, and both goals should be pursued. Nothing in these guidelines should be construed to discourage green building or sustainable design,” that was not reflected in the denial of the CoA.

The solar panel project grows out of a desire by members of the FUMC congregation to live out a commitment to stewardship of the environment and the Charlottesville community through their support of sustainable energy. We believe the solar panels are an expression of our religious faith and sets an example of one congregation’s response in acknowledging their obligations to address the climate crisis.

We are a community of faith that has made a commitment to remain in a historic building in the downtown area during a period when other congregations have left the area. We are happy to be part of a city that has been a vocal leader in renewable energy. We hope our appeal will be helpful to the city in developing a progressive and updated approach to applications like ours so that organizations and businesses can incorporate more readily the city’s stated sustainability goals. To that end, we respectfully ask City Council to reverse the BAR’s decision.

Thank you for receiving our appeal and we look forward to presenting to City Council.

Sincerely,



Rev. Alex Joyner
Pastor



Guy Moffat
Trustee



William L. Owens, AIA
Architect/Trustee

Enclosure: January 18, 2023 BAR presentation



FIRST UNITED METHODIST CHURCH Solar Panel Project

December 27, 2022

Description of Proposed Work

As part of green initiatives currently ongoing at the church, the congregation of First United Methodist Church (101 East Jefferson Street) wishes to consider adding solar panel arrays on several of the church building's roof surfaces. The church has received a promise of a large donation to seed the project and will fund the remaining cost through matching donations and the Federal tax credit now available to nonprofits as part of the Inflation Reduction Act of 2022.

The goal of the project is to reduce the church's demand for electrical service as much as possible through being supportive of renewable energy and demonstrating good stewardship of the environment. In order to accomplish this goal, the church wishes to maximizing the coverage of solar panels as much as practicable. As proposed, (see attached photo simulations) the church's electrical costs would be reduced by approximately 50% at a savings of about \$11,000 per year.

Following the presentation of the project concept to the BAR in October, the church met with its roofer and solar provider to reevaluate the project's approach, particularly to installation, since the mounting of the solar panels through the existing 100-year-old slate shingle roof was a major topic of concern at the meeting. The church now proposes to remove the slate shingles under the solar arrays and replace them with a waterproofing underlayment and dark colored asphalt shingles. This will allow for a more typical installation of the panels by the solar provider (see attached product information) and reduce the maintenance concerns for the church associated with a slate roof installation.

The existing slate tiles that are replaced for asphalt shingles will be salvaged and used to repair any damage to the exposed roof during installation or stored by the church for possible restoration if the solar panels are removed in the future. In addition, the roofer has found a source for new slate shingles that matches the original Buckingham Slate tiles, also for use in any required repair or future replacement.

Since the solar panels sit parallel to and only 6" above the roof surface, and project 12"-24" beyond the mounting rails, the asphalt shingles will not be visible, even when standing on the roof itself. The geometry of the arrays has been revised to a regular rectangular shape from the stepped geometry previously proposed to simplify the new roof installation and more easily disguise the asphalt shingles. All roof areas not covered by solar panels will remain visible as the existing slate shingles.

The solar panel arrays themselves will not be viewable on the church roofs from the surrounding block (see attached site photos) and only seen from the church parking lot and at a significant distance. Since the panels are mounted close to and matching the existing roof slopes, they should not be considered as changing the historic roofline or altering the character defining features of the church.

First United Methodist Church

Solar Panel Project

Photo Simulation 1



First United Methodist Church Solar Panel Project

Photo Simulation 2



First United Methodist Church

Solar Panel Project

Photo Simulation 3



First United Methodist Church Solar Panel Project

Site Photos – East Jefferson Street

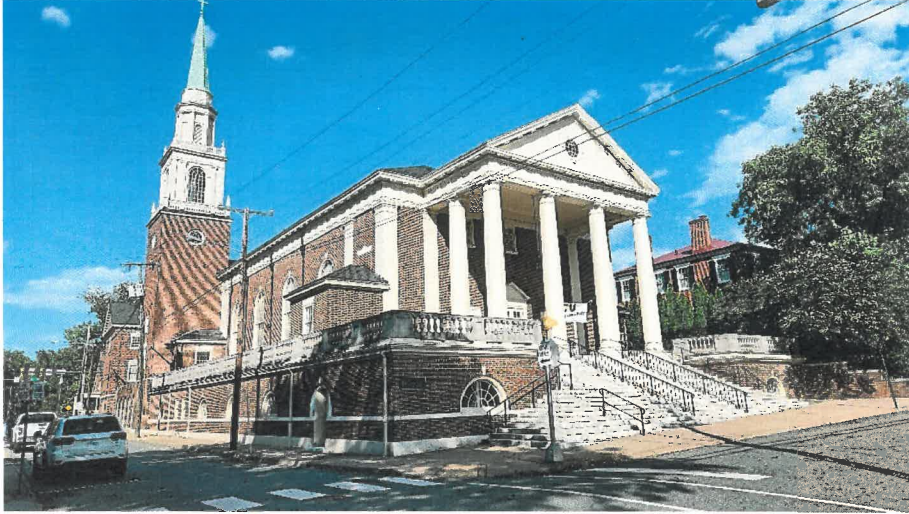

Property from E. Jefferson St./1st St. N. Intersection



Property from E. Jefferson St./2nd St. N.E. Intersection



Facing Property from E. Jefferson St.



Facing Property from E. Jefferson St.

First United Methodist Church Solar Panel Project

Site Photos – 1st Street N.



Property from E. High St./1st St. N. Intersection



Property from E. Jefferson St./1st St. N. Intersection



Facing Properties from E. Jefferson St./1st St. N. Intersection



Facing Properties from E. High St./1st St. N. Intersection

First United Methodist Church Solar Panel Project

Site Photos – 2nd Street N.E.



Neighboring Property from 2nd Street N.E.



Property from 2nd Street N.E.



Facing Property from E. High St./2nd St. N.E. Intersection



Facing Property from E. Jefferson St./2nd St. N.E. Intersection

First United Methodist Church Solar Panel Project

Site Photos – E. High Street



Property from E. High St./2nd St. N.E. Intersection



Property from E. High St./1st St. N. Intersection



Facing Properties from E. High St./1st St. N. Intersection



Facing Properties from E. High St./2nd St. N.E. Intersection

Moving Flashing Forward

We set out to design a flashing that checked all the boxes: fully waterproof, fast and easy to install correctly, economical, and strong enough to handle every environmental condition. FlashVue® does it all.

The optimized flashing design features a large viewport, for easy alignment with the pilot hole. And the GripCap® and GripCap+® sit snugly in place, so the lag can be driven single-handedly.

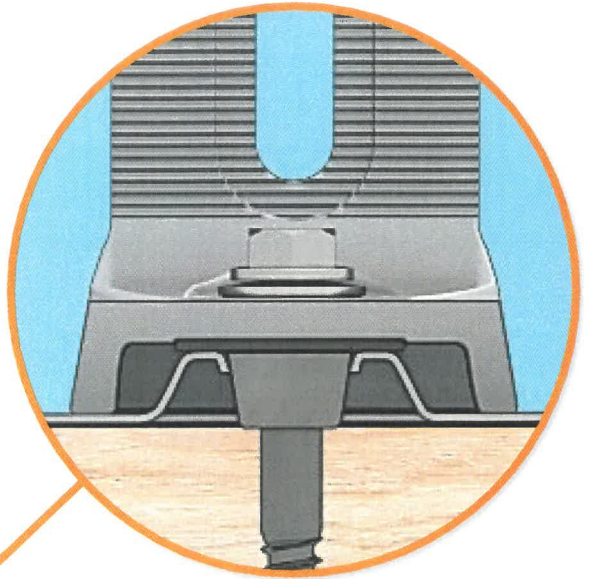

Three-Tier Water Seal, Reimagined

FlashVue®'s seal architecture utilizes three layers of protection. The viewport is elevated 0.30", and provides a "friction-fit" for the GripCap®. The GripCap® fully covers the viewport while a sealing washer adds another layer of protection. And an EPDM washer and lag bolt "seal the deal" in the

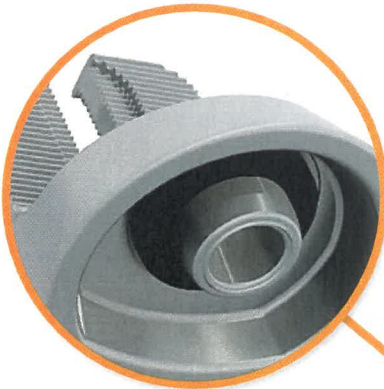

GripCap® & GripCap+®

The 360° capable GripCap® (2.74" tall) and GripCap+® (3.74" tall) can be placed in any orientation, and provide a "friction-fit" for easy installs. Push snug into the viewport, without worrying it will roll away or rotate while driving the lag.

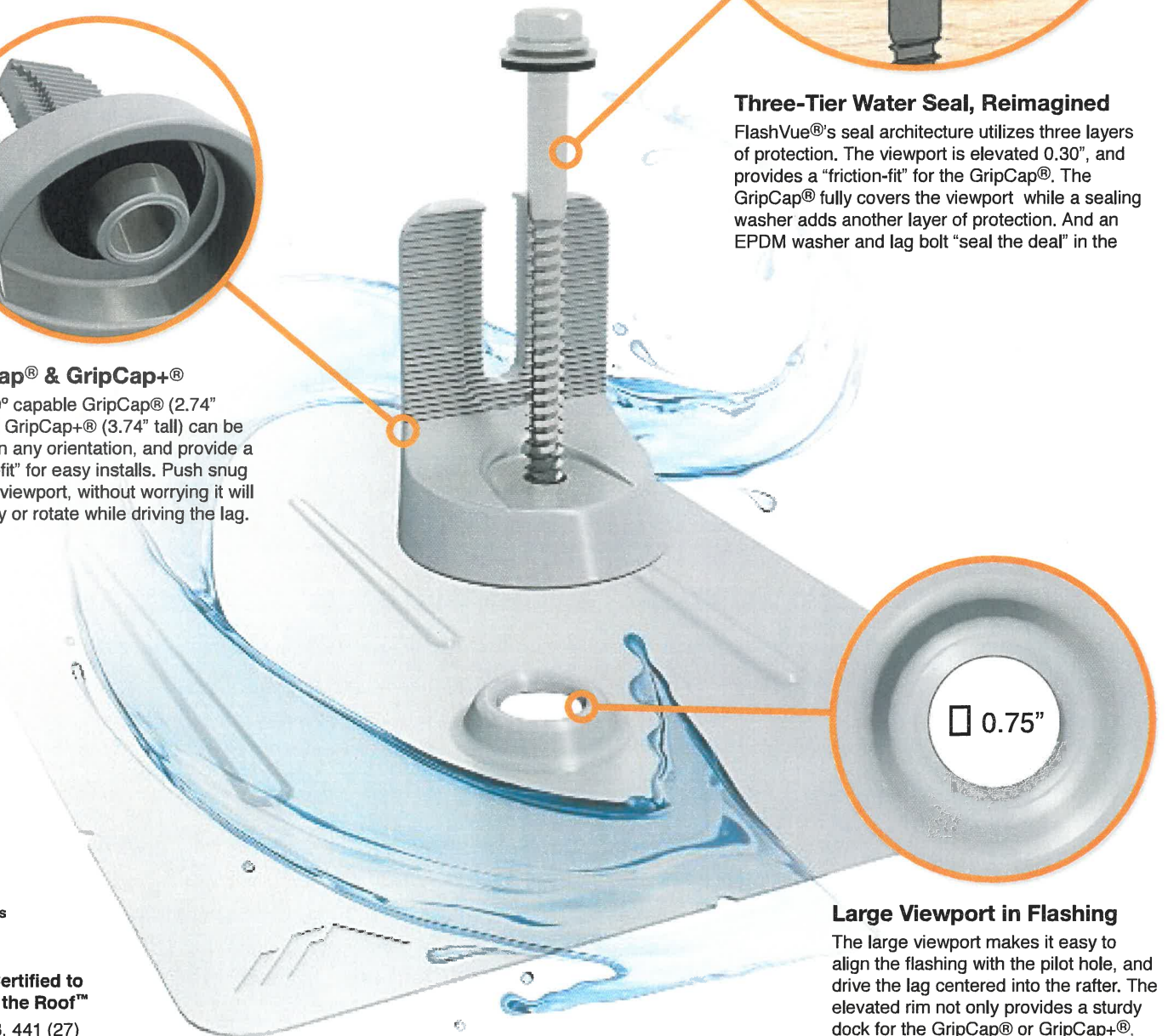

□ 0.75"

Large Viewport in Flashing

The large viewport makes it easy to align the flashing with the pilot hole, and drive the lag centered into the rafter. The elevated rim not only provides a sturdy dock for the GripCap® or GripCap+®, but increases water-shedding



Triple Certified to Protect the Roof™

UL 2703, 441 (27)
TAS 100(A)-95



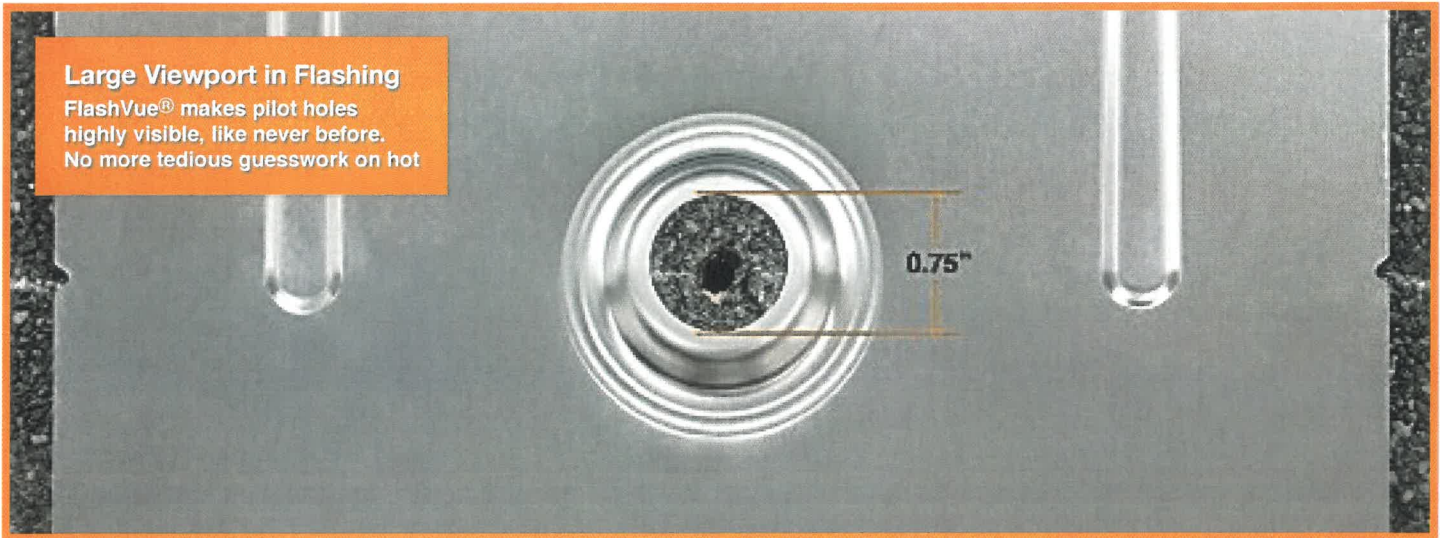

See Your Pilot Holes

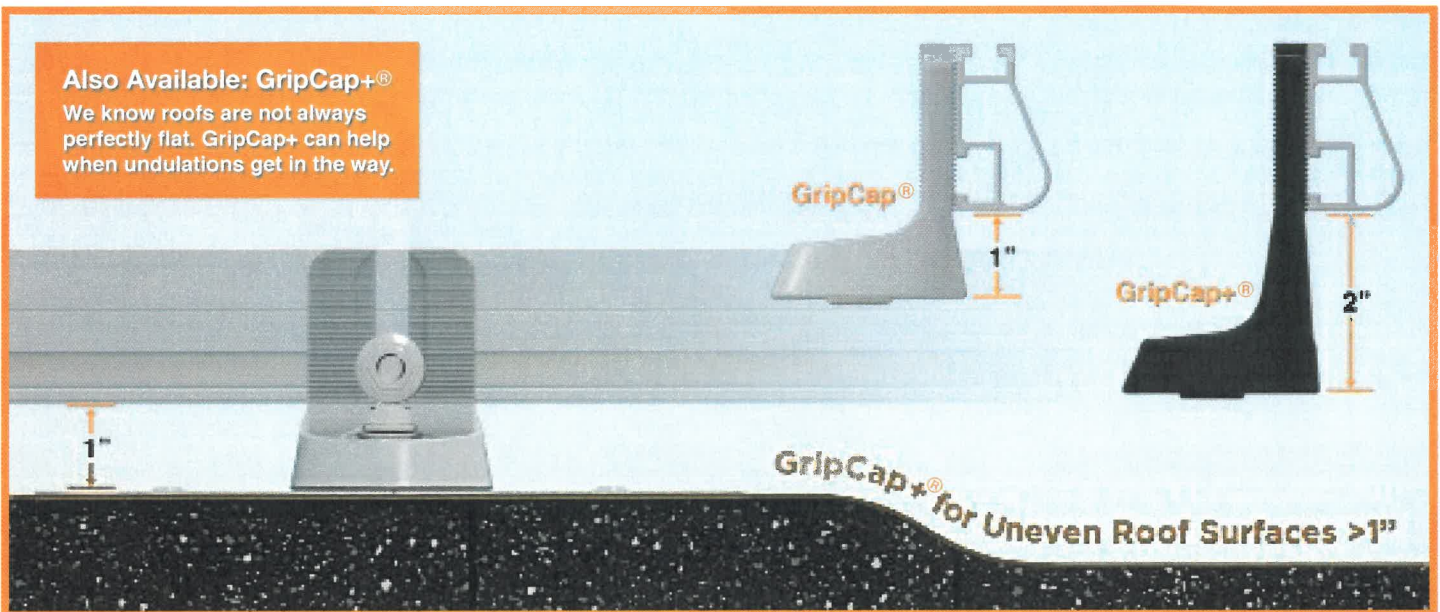

Solve Roof Undulations



Trusted Strength & Certification

-  **Attachment Loading**
FlashVue® has been tested and rated to support 1161 (lbs) of uplift and 353 (lbs) of lateral load.
-  **Structural Certification**
Designed and certified for compliance with the International Building Code & ASCE/SEI-7.
-  **Water Seal Ratings**
Passed both the UL 441 Section 27 "Rain Test" and TAS 100-95 "Wind Driven Rain Test" by Intertek.
-  **UL 2703 Listed System**
Conforms to UL 2703 mechanical and bonding requirements. See Flush Mount Manual for more info.

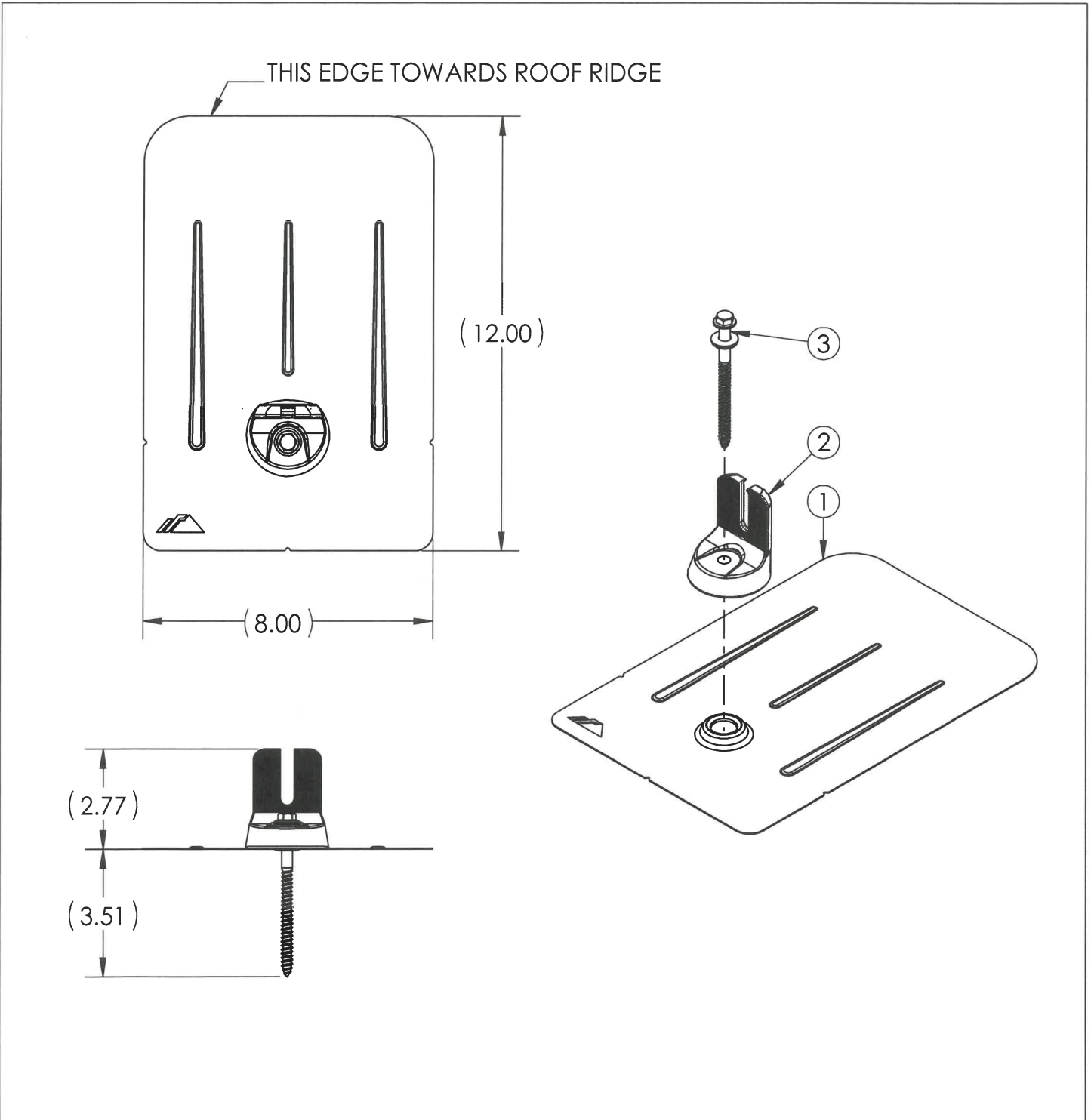

ITEM NO.	DESCRIPTION
1	FM FLASHING, MILL OR BLACK
2	GRIP CAP, MILL OR BLACK
3	LAG & BONDED WASHER, 5/16 X 4.25, 7/16 HEX HEAD

FLASHVUE®		
SIZE A	DO NOT SCALE DRAWING	
SCALE: 1:4	WEIGHT: 0.6 lbs	SHEET 1 OF 1

Installation

Tools Required: tape measure, chalk, approved sealing materials, driver with 1/4" bit and 7/16" hex socket

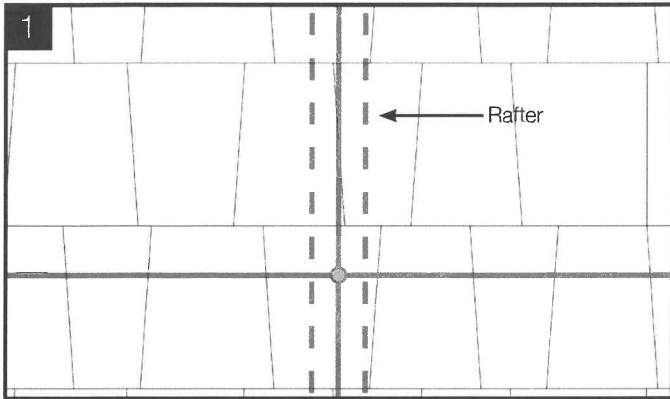

1. Locate rafters and snap vertical and horizontal lines to mark locations of flashings. Drill 1/4" pilot holes, then fill with roofing manufacturer's approved sealant.

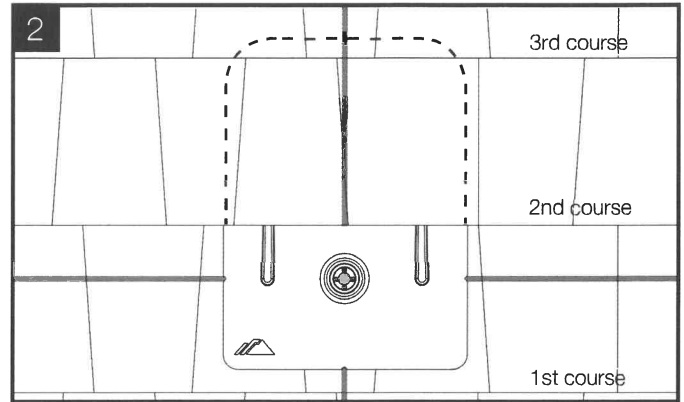

2. Slide flashing between 1st and 2nd course, so the top is at least 3/4" above the edge of the 3rd course and the bottom is above the edge of the 1st course. Line up pilot hole with view port.

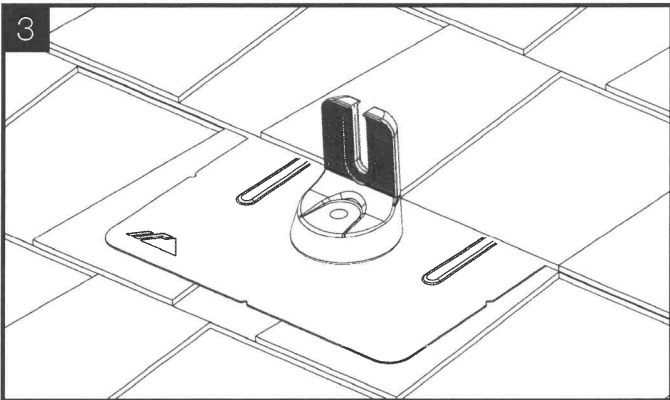

3. Press Grip Cap onto flashing in desired orientation for E/W or N/S rails.

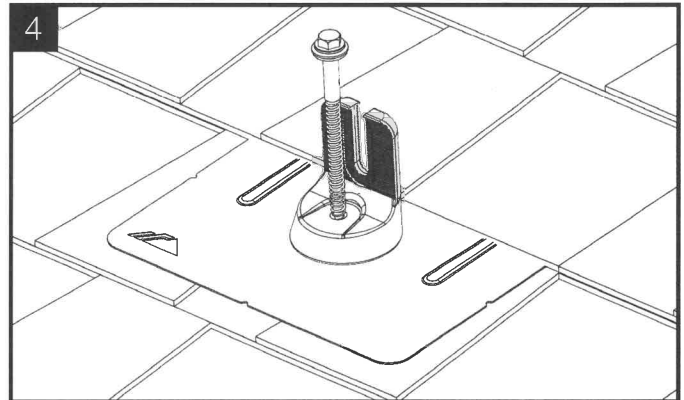

4. Insert lag bolt with EPDM backed washer through flashing. Tighten lag bolt until fully seated. FlashVue is now installed and ready for IronRidge XR Rails.

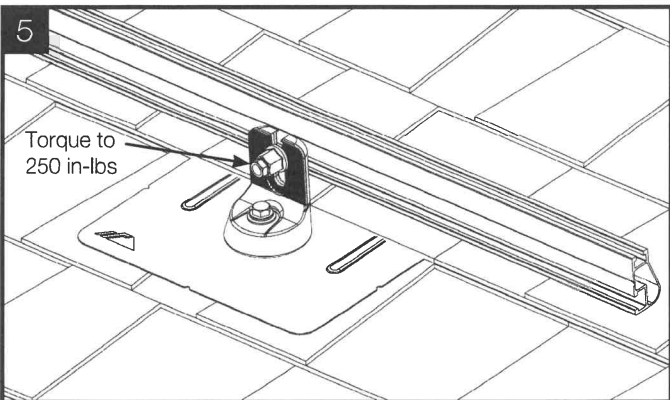

5. Attach rails to either side of the open slot using bonding hardware. Level rail at desired height, then torque to 250 in-lbs (21 ft-lbs).

Structural Certification

Designed and Certified for Compliance with the International Building Code & ASCE/SEI-7.

Water Seal Ratings

Water Sealing Tested to UL 441 Section 27 "Rain Test" and TAS 100(A)-95 "Wind Driven Rain Test" by Intertek. Tested and evaluated without sealant. Any roofing manufacturer approved sealant is allowed.

UL 2703

Conforms to UL 2703 (2015) Mechanical and Bonding requirements. See Ironridge Flush Mount Installation Manual for full ratings.

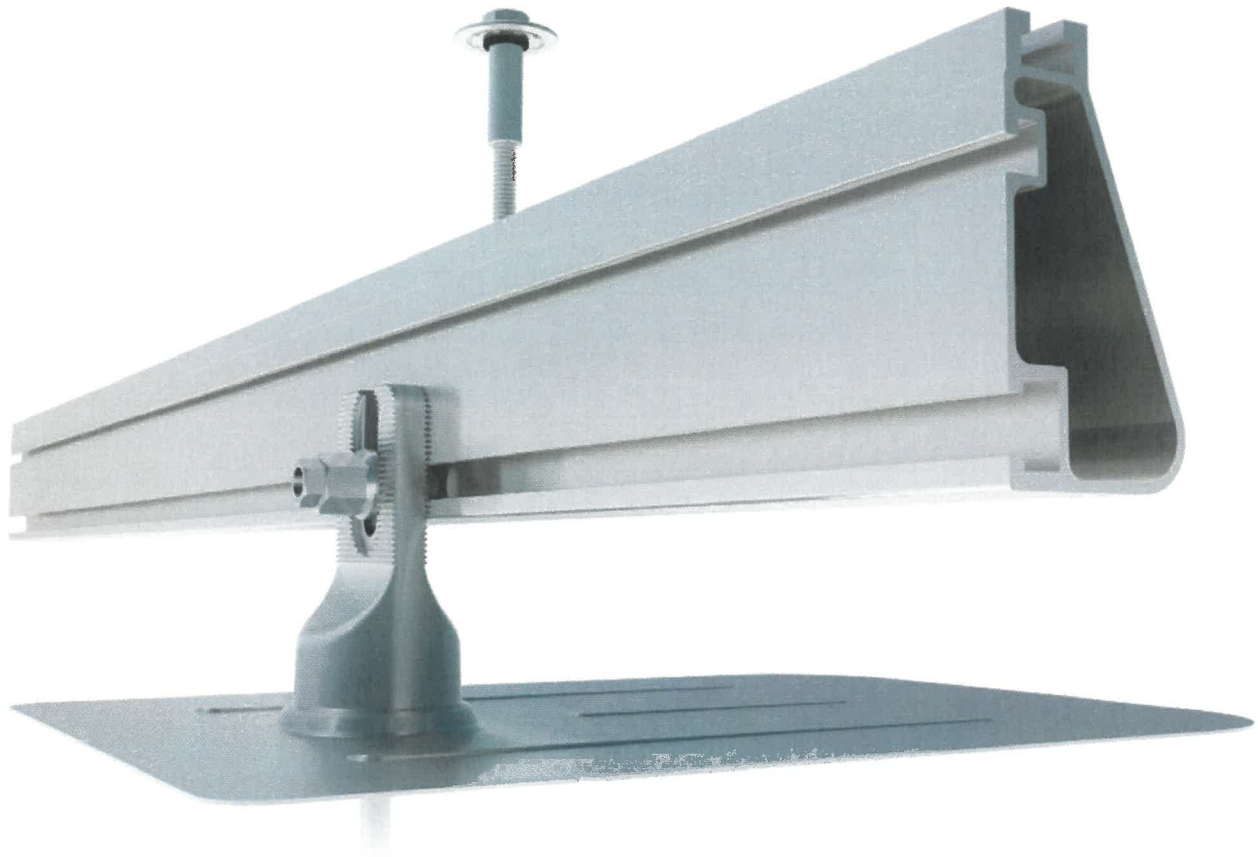

Built for solar's toughest roofs.

IronRidge builds the strongest mounting system for pitched roofs in solar. Our components have been tested to the limit and proven in extreme environments, including Florida's high-velocity hurricane zones.

Our rigorous approach has led to unique structural features, such as curved rails and reinforced flashings, and is also why our products are fully certified, code compliant and backed by a 25-year warranty.



Strength Tested

All components evaluated for superior structural performance.



PE Certified

Pre-stamped engineering letters available in most states.



Class A Fire Rating

Certified to maintain the fire resistance rating of the existing roof.



Design Assistant

Online software makes it simple to create, share, and price projects.



UL 2703 Listed System

Entire system and components meet newest effective UL 2703 standard.



25-Year Warranty

Products guaranteed to be free of impairing defects.

XR Rails ☺

XR10 Rail



A low-profile mounting rail for regions with light snow.

- 6' spanning capability
- Moderate load capability
- Clear and black finish

XR100 Rail

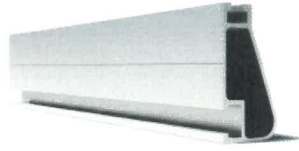

The ultimate residential solar mounting rail.

- 8' spanning capability
- Heavy load capability
- Clear and black finish

XR1000 Rail

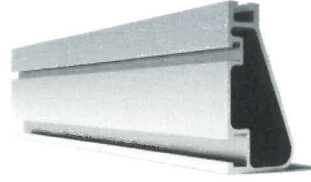

A heavyweight mounting rail for commercial projects.

- 12' spanning capability
- Extreme load capability
- Clear anodized finish

BOSS™ Bonded Splices

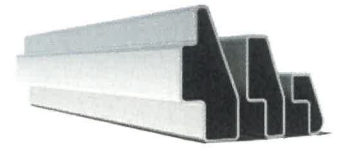

Bonded Structural Splices connect XR Rails together.

- Integrated bonding
- No tools or hardware
- Self-centering stop tab

Clamps & Grounding ☺

UFO™



Universal Fastening Objects bond modules to rails.

- Fully assembled & lubed
- Single, universal size
- Clear and black finish

Stopper Sleeves

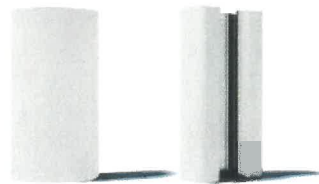

Snap onto the UFO to turn into a bonded end clamp.

- Bonds modules to rails
- Sized to match modules
- Clear and black finish

CAMO™



Bond modules to rails while staying completely hidden.

- Universal end-cam clamp
- Tool-less installation
- Fully assembled

Bonding Hardware



Bond and attach XR Rails to roof attachments.

- T & Square Bolt options
- Nut uses 7/16" socket
- Assembled and lubricated

Attachments ☺

FlashFoot2™

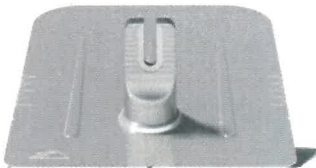

Flash and mount XR Rails with superior waterproofing.

- Twist-on Cap eases install
- Wind-driven rain tested
- Mill and black finish

FlashVue™

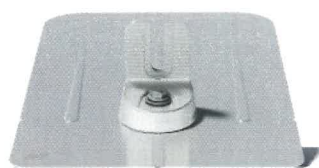

Flash and mount conduit, strut, or junction boxes.

- Twist-on Cap eases install
- Wind-driven rain tested
- Secures 3/4" or 1" conduit

Knockout Tile

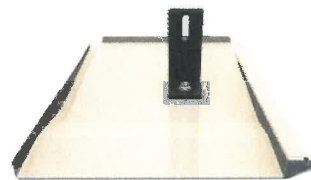

Replace tiles and ensure superior waterproofing.

- Flat, S, & W tile profiles
- Form-fit compression seal
- Single-lag universal base

All Tile Hook



Mount on tile roofs with a simple, adjustable hook.

- Works on flat, S, & W tiles
- Single-socket installation
- Optional deck flashing

Resources



Design Assistant

Go from rough layout to fully engineered system. For free.

Go to IronRidge.com/design

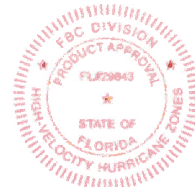

Endorsed by FL Building Commission

Flush Mount is the first mounting system to receive Florida Product approval for 2017 Florida Building Code compliance.

Learn More at bit.ly/floridacert



Attachment 2

City staff response to the appeal of the BAR’s January 18, 2023 decision denying a certificate of appropriateness for installation of rooftop photovoltaic/solar panels at First United Methodist Church located at 101 East Jefferson Street, (BAR 22-10-02).

(Throughout this Response, references to “Staff” represent the collective positions of the BAR, the City’s Preservation and Design Planner, and the City Attorney’s Office.)

EXECUTIVE SUMMARY OF STAFF’S RESPONSE

This appeal has been taken by the pastor and two trustees of First United Methodist Church at 101 East Jefferson Street, the property that is the subject of this appeal. For the reasons stated below (within specific responses to each of the Appellants’ separate contentions), Staff’s position is that the concerns expressed by the Appellant do not provide a basis for the BAR to approve a Certificate of Appropriateness, (CoA) under the standards set forth within Chapter 34 (Zoning) Article II (Overlay Districts), Division 2 (Historical Preservation and Architectural Design Control Overlay Districts).

Council’s Role on Appeal: Reference Sec. 34-286(b) and (c) of the City Code (Chapter 34 of the City Code is referred to as the “Zoning Ordinance”). Council’s role on appeal is to serve as the final decision-maker. Council must consider the appeal, consider the BAR’s position communicated in this Response as the “Staff Response”, and Council may consider any other information, factors or opinions it deems relevant to the application. Council should make a final decision on the application and should not refer the matter back to the BAR.

Staff Response to Appellant’s Contentions

Paragraph 1

Appellant: “We feel the BAR’s vote was based on out-of-date Architectural Design Control Districts Guidelines [*design guidelines*] that are now in conflict and incongruous with the current vision and goals of the City of Charlottesville to promote the use of sustainable energy.”

Staff Response: The BAR’s evaluation of this CoA request is limited to the criteria proscribed in City Code Section 34-276 - *Standards for review of construction and alterations*. The standards (see below) include by reference the City’s 2012 ADC District Design Guidelines and the Secretary of the Interior’s Standards (*Secretary’s Standards*), last updated in 2017.

Regarding the installation of solar panels and the removal of [sections of] the historic character-defining slate roof, both the guidelines and Secretary’s Standards are unambiguous and do not support the CoA request, as submitted. However, the guidelines and the Secretary’s Standards cannot be read as in conflict with sustainability; in fact, they embrace and encourage it: historic preservation is the epitome of *reuse-reduce-recycle*. (See the January 18, 2023 BAR meeting minutes, Attachment 4, re: the BAR

discission on weighing the benefits of retaining the slate roof vs installing the solar panels.)

The design guidelines encourage creative and proactive thinking to incorporate sustainable technologies into historic districts and structures. Sustainability is the first section in the *Introduction* (Chapter I) to the design guidelines. The Secretary’s Standards offer a range of specific guidance on how solar might be successfully--and unsuccessfully-- incorporated into renovations and rehabilitations. The BAR’s design guidelines are overdue for an update, but the standards of review, overall, are neither obsolete or useless regarding sustainability and new technologies. They do not prohibit or prevent the installation of solar panels. They offer guidance for evaluating when an installation is—and is not--appropriate, relative to historic preservation. (The referenced Secretary’s Standards are on pages 6 and 7 of the January 18, 2023 BAR staff report.)

For example, the Secretary’s Standards regarding Solar Technology recommends that solar devices be installed in *a compatible location on the site or on a non-historic building or addition where it will have minimal impact on the historic building and its site*. The BAR’s primary concern was the sanctuary roof, so there was support for solar panels on the north building and other secondary locations. During the several discussions, the BAR even suggested the church consider erecting a frame over the parking lot to accommodate the panels. (See the Discussion on page 2 of January 18, 2023 BAR staff report and the comments n on page 2 of the October 18, 2022 meeting minutes, Attachment 3.)

Paragraph 2

Appellant: “The ADC District Guidelines were last revised in September 17, 2012 and, as admitted by the BAR during our meeting on January 18, 2023, are in need of updating, particularly in regard to renewable energy and specifically solar panels. Since the guidelines’ last revision, the City has approved numerous statements, standards, plans, amendments and initiatives to not only support and encourage sustainable energy, but also to make it a matter of governing policy.”

Staff Response: The statement accurately represents the BAR’s discussion.

Paragraph 3

Appellant: Reference to *City Council Vision Statement 2025*

Staff Response: The BAR’s evaluation of this CoA request is limited to the criteria proscribed in City Code Section 34-276 - *Standards for review of construction and alterations*. These standards (see below) include by reference the City’s ADC District Design Guidelines and Secretary’s Standards. Following that evaluation, Section 34-284(b) requires the BAR find that a request either: a) meets those specific standards or applicable provisions of the Design Guidelines [approval of the CoA]; or b) based on those standards and provisions, is incompatible with the historic, cultural or architectural

character of the district in which the property is located or the protected property that is the subject of the application [denial of the CoA]. In brief, the BAR does not disagree with or dismiss the referenced City policy; however, the review standards available to the BAR include only those proscribed in the City Code.

Paragraph 4

Appellant: Reference to *Solarize Charlottesville campaign*,

Staff Response: See comment above for Paragraph 3.

Paragraph 5

Appellant: Reference to *Charlottesville Standards & Design Manual*

Staff Response: See comment above for Paragraph 3.

Paragraph 6.

Appellant: Reference to *City of Charlottesville Strategic Plan*.

Staff Response: See comment above for Paragraph 3.

Paragraph 7.

Appellant: Reference to *City of Charlottesville Comprehensive Plan*

Staff Response: See comment above for Paragraph 3.

Paragraph 8.

Appellant: Reference to *Charlottesville Climate Action Plan*

Staff Response: See comment above for Paragraph 3.

Paragraph 9.

Appellant: “Additional examples and references to the City's website could be included, but it seems clear that in the ten years since the ADC District Guidelines were last updated the City has dramatically increased its support of sustainable energy. The City's website Renewable Energy: Solar page even highlights FUMC on its Charlottesville Solar: Rooftop Potential map. And while the ADC District Guidelines state that "Sustainability and preservation are complementary concepts, and both goals should be pursued. Nothing in these guidelines should be construed to discourage green building or sustainable design," that was not reflected in the denial of the CoA.”

Staff Response: See comments above for Paragraph 2 and Paragraph 3. Additionally, since 2010, the BAR has reviewed 15 CoA request for solar panels. All were approved. Except for the FUMC project, there have been no requests to install solar panels on a slate roof. Since adoption of the current design guidelines in 2012, the BAR has reviewed and approved 11 CoA requests for solar panels. All were approved. (See list in the Appendix of the January 18, 2023, BAR staff report.)

Paragraph 10.

Appellant: “The solar panel project grows out of a desire by members of the FUMC congregation to live out a commitment to stewardship of the environment and the Charlottesville community through their support of sustainable energy. [...]”

Staff Response: No comment. Refers to matters outside of BAR purview.

Paragraph 11.

Appellant: “We are a community of faith that has made a commitment to remain in a historic building in the downtown area during a period when other congregations have left the area. [...]”

Staff Response: No comment. Refers to matters outside of BAR purview.

Referenced City Code Sections

Section Sec. 34-284. - BAR review and hearing.

[...]

- b) In considering a particular application the BAR shall approve the application unless it finds:
 1. That the proposal does not meet specific standards set forth within this division or applicable provisions of the design guidelines established by the board pursuant to section 34-288(6); and
 2. The proposal is incompatible with the historic, cultural or architectural character of the district in which the property is located or the protected property that is the subject of the application

Sec. 34-276. - Standards for review of construction and alterations.

Whether the material, texture, color, height, scale, mass and placement of the proposed addition, modification or construction are visually and architecturally compatible with the site and the applicable design control district;

- 1) The harmony of the proposed change in terms of overall proportion and the size and placement of entrances, windows, awnings, exterior stairs and signs;
- 2) The Secretary of the Interior Standards for Rehabilitation set forth within the Code of Federal Regulations (36 C.F.R. §67.7(b)), as may be relevant;
- 3) The effect of the proposed change on the historic district neighborhood;

- 4) The impact of the proposed change on other protected features on the property, such as gardens, landscaping, fences, walls and walks;
- 5) Whether the proposed method of construction, renovation or restoration could have an adverse impact on the structure or site, or adjacent buildings or structures;
- 6) When reviewing any proposed sign as part of an application under consideration, the standards set forth within Article IX, sections 34-1020, et seq. shall be applied; and
- 7) Any applicable provisions of the city's design guidelines (see section 34-288(6)).

Sec. 34-288. - Responsibilities of BAR.

The function of the board of architectural review ("BAR") shall be to administer the provisions of this division. In carrying out this responsibility the BAR shall:

- 1) Approve, deny, or approve with conditions applications for certificates of appropriateness in accordance with the provisions of this division.
- 2) [...]
- 3) [...]
- 4) [...]
- 5) [...]
- 6) Develop and recommend to the city council for its approval design guidelines for the city's architectural design control districts ("design guidelines"), consistent with the purposes and standards set forth within this division. The BAR shall develop the design guidelines in consultation with the city's urban design committee and after seeking input from business and property owners in the various districts. Guidelines developed by the board shall become effective upon approval by city council and thereafter shall have the status of interpretive regulations. The BAR shall undertake a comprehensive review and update the design guidelines at least once every five (5) years.

**City of Charlottesville
Board of Architectural Review
October 18, 2022 - BAR Minutes (draft)**



Re: First United Methodists Church BAR Appeal

Members Present: Ron Bailey, Carl Schwarz, Breck Gastinger, James Zehmer, Dave Timmerman, Tyler Whitney

Staff Present: Patrick Cory, Jeff Werner, Remy Trail

Certificate of Appropriateness

BAR # 22-10-02

101 East Jefferson Street, TMP 330190000

North Downtown ADC District (contributing)

Owner: First United Methodist Church

Applicant: William L. Owens, AIA

Project: Install solar panels

Jeff Werner - [summarized Staff Report]

William Owens, Applicant – I am the architect shepherding the project for First United Methodist Church. I am also a trustee of the church. The church has received an offer of a sizeable donation to add solar panels to the building and to reduce the church’s electrical demands as part of an ongoing green initiative at the church. The church’s goal is to cover at least 50 percent of their yearly electrical expenses at a savings of about \$10,000 to \$15,000 per year through the use of solar panels. The photo simulations, you have been provided, show the number and placement of solar panels as estimated by Tiger Solar as best to achieve this goal. The church would like to have an understanding of what the city and BAR would approve visually for the placement of panels on the existing roof. The roof surfaces of the church are not visible from the surrounding block except for the church’s own parking lot and directly in front of their courtyard. Only those at a distance and elevated will be able to see the solar panels. I also provided information on how the roofer would propose to attach the solar panel rack system through the existing slate roof. All electrical connections would be made through the attic or basement, except for a single conduit running up the back panel array and down the north face of the steeple to the existing electrical service in the courtyard. The church is more than happy to provide the city additional details on the design of the system as it is engineered. They would have a sense to what extent they would be permitted to have panels on the roof surfaces before going through the time and effort to have the system designed.

QUESTIONS FROM THE BOARD

Mr. Schwarz – The photo simulations you are showing us, that’s what you would like to do?

Mr. Owens – Yes. That is what Tiger Solar is telling us would maximize the solar gain for the project. It is around 200 [to] 220 panels. It is not totally defined. The goal was to reduce

the church to as close to net zero as possible. We're still working through the numbers on kilowatt hours. We have everything from at least 50 percent up to 75 percent, depending on where we place them. This is the estimate based for solar design, where they should be. The initial submittal to staff showed them on the portico roof that I had corrected immediately. Hopefully, you have the newer submission, which has them removed from the portico and put on the back courtyard roof.

Mr. Gastinger – I have a question about the mounts that was included in the packet. How often do those need to be in use? Are they essentially at the corner of every panel?

Mr. Owens – My understanding is that the panels mount on a continual channel. These mounts would be every six feet to support this continuous channel. Once we have a sense of where this is going to go, we will work with the roofer on what is involved. We have an obligation to this donor to see this through. They have specifically pledged this money for this specific idea.

Mr. Timmerman – Last time, somebody had a good idea of potentially locating the panels in the parking lot on the northeast side. Has that been looked at as a potential option as a way of taking some of the panels off the roof/off the slate?

Mr. Owens – No. I am not sure what is meant by that.

Mr. Timmerman – I have been in car parks where there is a framework. The panels mount overhead ten feet up and angled in a way to catch the sun's rays. They also create some shading for the cars.

Mr. Owens – My presumption would be that would be less desirable than disguising them on the roof. We haven't really explored that. I guess it is something we can talk about.

COMMENTS FROM THE BOARD

Mr. Gastinger – We should break this into two parts. I am guessing there are two major considerations. One is the impact on the historic district and the roofline of the structure. The second consideration being the detail and the issues relative to the preservation of the slate. Let's talk about the first one. Are there questions or concerns about the panels' installation relative to the historic district or to the roofline?

Mr. Zehmer – Within the guidelines under Rehabilitation, Section G-Roof, Note-8, place solar collectors and antennae on non-character defining roofs or roofs of non-historic adjacent buildings. We need to determine whether the main roof of the sanctuary is a character defining roof. We need to get over that hurdle first. I would argue that it is the main roof of the building. I also think they have a valiant goal. If there are ways we can help them achieve it, we should.

Mr. Schwarz – The fact is that it is not really visible from anywhere within close proximity. It is a character defining roof. You have to be standing back pretty far to see the roof. I agree

with them not putting them on the portico. Anywhere else would be acceptable to our guidelines. I also do not believe it will change the profile of the roof to obscure any massing of the building. They are so relatively flat to the roof. I think that helps.

Mr. Gastinger – That slim profile is important to me. It doesn't seem like it is going to really substantively change the profile against the sky or the roof itself. In an ideal world, they might be tiles. In some day, they might be tiles. I really wouldn't think there would be an issue with it. For me, I don't think it has an adverse impact on the district or the structure from a profile standpoint.

Mr. Timmerman – I felt that way last month when I was looking at all of the street views. You can't really see them. I guess looking at this image of the solar panels on a fairly identifiable historic building has changed my mind. In keeping with the standards, the minor buildings are one thing. The next time we see this shot, are we prepared to see the oldest churches in the downtown with that roof covering? For me, it comes down that I am more concerned about the material of the roof, the damage they could potentially do. I am concerned about having a viable, really durable material in the slate, and doing something to it that will adversely affect it.

Mr. Bailey – I practically walk by the church every day. I have never noticed the roof. I don't think it is character defining in that sense. It is an old, durable roof. If the church is not worried about the fact that it may break down, why should I worry about it?

Mr. Whitney – I would be in favor of proceeding with the solar panels and letting the church go the route of installing it. If it is visible, it is something of the church in a forward thinking direction. Since it is not visible by most viewpoints, I don't see any reason why they shouldn't proceed going with the solar panels.

Mr. Gastinger – Let's talk about the potential risk to the slate. The city recently explored replacing the slate on Key Recreation Center. We went through an enlightening discussion about the care and repair necessary and the state of slate supply currently in the market. This was a recent conversation we have had amongst the BAR.

Mr. Zehmer – You know that the Buckingham slate has dried up in the quarry. It is really difficult to get these days. The message is to be cautious. It seems to me that this is an installation method that would potentially do a lot of damage to the roof; not just for cutting the slate with the grinder and popping that slate that you need for each of these mounting points. The fact is that the installer is going to be walking all over your slate roof. The potential to break slate is very high. I say that as a cautionary note and having worked on slate roofs. There is a lot of caution that would go behind this. It would behoove you all to do some research and see if there are other slate roofs that this company has worked on and can show you where they have successfully installed the solar panels. Go see those projects so you can rest assured that they can do a good job. Talk to their clients as well as the contractor to make sure the client was happy with the job. It might be worth exploring within your parking areas. It might be where a solution is actually less expensive than going on the roof.

It might be worth exploring. If you can find something else that might be acceptable and is less expensive and meet your energy goals, maybe that is a ‘win-win.’

Mr. Bailey – Would you be willing to watch a solar farm built next to the church in a historic district?

Mr. Zehmer – I am not over the fact that it is a character defining roof. It is the main roof of the main part of the sanctuary.

Mr. Timmerman – For me, it would depend on the design of it. I think you can design something in a reasonable way. The parking lot, as it sits right now, is pretty empty.

Mr. Owens – We would have to elevate it to get around the trees. That’s the advantage of the sanctuary since it is up high.

Applicant #2 – Ten feet off the ground is not going to do it. We have another building. There is a 6 foot rock wall with a big house. It has shade. To get it through approval down there, there are a lot of things there.

Mr. Werner – If this was an asphalt roof, I probably would have had this on the Consent Agenda. Breck asked the right question. “What is our charge?” I am probably speaking more from my years in construction than necessarily from the guidelines. It is appropriate for the BAR to be asking that question. I don’t know.

Mr. Gastinger – I think that we would agree that the slate roof is a character defining feature of this church. If the proposal was to take the slate off and sell it to the city for Key Recreation Center, I don’t think we would approve that. We do have a role in trying to steer towards the protection of that roof and the protection of that detail in materiality. As citizens, we want to make sure that you do that, look at this material carefully. It obviously may save the congregation money in the long term. We don’t want it to be a risky move that could cause other headaches down the road. I wish there was a system that allowed for fewer penetrations. It seems like a very labor intensive and detailed installation on a delicate surface. I would also note, as someone who sits on a church board, if that risk is seen as too high, I would encourage you to think creatively about the strength of having a congregation. There are maybe things that you can do at the congregation scale of many residences throughout the city that could have as much or bigger impact overall.

Mr. Timmerman – I am looking at the parking lot. There’s a pretty clear view of the west side of the main roof.

Mr. Schwarz – A question for the installer: If the technology changes and you want to take these off and put a different panel on, what is the process of putting the slate back? It looks like you’re replacing more than just one slate. If you took one of these mounts off, how many slates are damaged, destroyed, removed, or would have to be to put a new slate back in that spot? What would be the scale of replacement should the solar panels have to be removed?

Mr. Owens – I wasn't completely thrilled with the system and with the penetrations that were involved. I couldn't get as much participation from the roofer as I wanted (ahead of time) to resolve this. I would pursue it myself. I would much rather see something that was removable that replaced the slate and the slate could be salvaged in theory and then put back rather than damaging a slate by doing it. That's something we haven't resolved. We're here because we have a specific obligation to us. The donor is wanting to give a large amount of money for this specifically (yes or no) to see that out. We're trying to respond back to them, as a first step here. We will work out the details to what you think is warranted to make you all comfortable with what we're doing. I certainly do understand. A lot of this could have been addressed by the solar company and the roofer. We could have hashed out something to save us a second visit. I agree with some of your comments in theory.

Applicant #2 – We want that roof. We're not going to do something that we feel and we can't prove that it is going to be done properly. We intend to keep the roof. We have no reason to think that it is going anywhere else. The engineering and the research is going to be done. We don't want to do it and come here and say we can't put solar panels on a roof. Construction is slammed. It still is slammed in Charlottesville. Once we get the 'go ahead,' we can roll. We will not put it on that roof if it is going to delay or hurt the life of that roof.

Mr. Gastinger – I am sure that you are more worried about that than we are.

Applicant #2 – We have to deal with the leaks. We have enough of them. We understand. We're making arrangements that we're not going to put the panels straight through without any way to walk between them. We have to get to them. Slate contracts and expands all the time. We're going to have to get behind those panels to fix it. We will make arrangements. We're going to do that without taking the whole roof off. We have thought through things. We know what we have to do. We certainly expect to be convinced in our own mind that this is going to be done and the roof will be lasting. If we can't, the solar panel might go away.

Mr. Gastinger – I felt generally that there was consensus that the panels could be placed on this roof without adverse effect to the historic district or the building because of its low profile. What I heard is that we have concerns about the slate. There is some openness if we had more information. You feel like this is going to protect the roof. That is something we would be prepared to support. It might be that there is a different system. It might be there is someone who has a direct experience with that installation. Generally, this Board supports your effort and just wants to make sure we can do what we can to support you doing it the best way possible.

Mr. Schwarz – It sounds like there are four of us tonight that seem to be supporting this idea. One person, who left earlier, denied a previous solar panel application. It might be closer than what it looks.

Mr. Gastinger – I would also note that, not only is Jeff [staff] open for continued conversation, if you have questions or get more information, it is also possible to reach out to Board members. We can give you feedback prior to the next meeting.

Mr. Owens – I understand the concern with the installation. I am not sure I am clear where we are with a ‘yes’ or ‘no’ with us going further. If we get a ‘no,’ what do I do when I leave here is substantially different. I certainly understand the concerns with the installation. I am pursuing a better solution possibly there. I don’t disagree.

Mr. Gastinger – There’s a majority here that would support the location of the panels on the roof.

Mr. Bailey – Shouldn’t we go through that with a motion? That’s what you’re here for.

Mr. Owens – If Board members are not here, they are not here.

Mr. Bailey – There is a suggested motion in the packet. (Mr. Bailey did read the motion from the packet).

Mr. Gastinger – I don’t know if there’s the same amount of comfort with the detail yet; not that it wouldn’t be approvable. It seems like we need to have a little bit more information.

Mr. Bailey – I can make the motion to approve. We can vote and they can decide what to do next.

Mr. Owens – What I would be looking to avoid is that we have to come back and we have a different variable on the Board and we wasted the time to pursue something.

Mr. Schwarz – As Breck recommended, it might be a good idea to reach out to us outside of the meeting by email and specifically reaching out to the members who are not here. I don’t think we can give them that because we have an incomplete Board. I don’t think we can vote tonight.

Mr. Owens – Can you do the approval of the installation rooftop solar units with the caveat providing additional information on the installations to still be reviewed?

Mr. Schwarz – We have gotten into trouble with that in the past.

Applicant #2 – Is the installation reviewable by the city?

Mr. Werner – This is another interesting question of what requires a building permit for roofing. I know there is an electrical permit involved. I don’t know about a roofing permit. It would not be an evaluation of the methodology. I am thinking back to when we talked about Key Recreation Center. I was surprised when they said that they would have 30 percent salvageable material. Having worked with and talked with the applicant about this, there is this understanding that the congregation is going to evaluate that. They’re not going to put somebody up on that roof if it damages the roof. I don’t know if you can say that in a motion. That’s the sense I get. They can’t move forward with that detailed evaluation without an affirmative or a negative. The choice would be to make a motion and make a vote. If it is a negative vote, they can appeal that to Council or take it as it is. If it’s a positive vote, they

can move forward with the COA. If you have any ideas of provisions/conditions that don't require a [later] subjective decision on my part. We can move forward with that.

Mr. Owens – You're not comfortable doing 50-50 or something. They do that in the county more often. I understand your concerns and they are warranted. I would like to address them. I would like to get out of here with enough confidence that we can do that and be able to resolve that. One proposal that the solar company had was to completely remove the roofing underneath the panels that would not be visible and put something that is actually easier to deal with as far as walkability. We decided that wasn't the way to go. It does provide an easier solution on one end.

Mr. Werner – Another option that the BAR has (you have 30 days to act on this). You can move to defer to the November meeting. They would have to come back and present this. You do have that ability. It forces the issue, but it is available.

Mr. Gastinger – I want to ask [the BAR] if you feel that you could support this project with a little more confidence in the installation method. The panels are located as they are proposed either with a little more information or an improved mounting method. Do you feel that you could support this project?

Mr. Timmerman – I would support it with a condition that we would avoid the planes that you could see from the ground. That probably knocks out the east sides. For me, it is the same thing as Key Recreation Center. I feel that we are here to maintain the unique character of the downtown. That's our main job. That is something I appreciate every time I go over the Belmont Bridge. I see that roof. That's one of the many details that I respond to as being part of the things I appreciate about the downtown.

Applicant #2 – The southeast side of the sanctuary dropped [?] 46 kW of power. That's half of the solar. We lose that whole sanctuary roof.

Mr. Gastinger – Ron, you're supportive as it is?

Mr. Bailey – I am supportive as it currently is. I can't believe these guys are going to let their roof leak if they can avoid it.

Mr. Schwarz – In theory, I side with Ron. I need to see more detailing.

Mr. Gastinger – I am seeing 4 votes in favor with a little more assurance on the detailing of the installation. There are 2 votes with some reservations. I can't speak to the outstanding votes.

Applicant #2 – Can we get approval for the panels and come back before doing any installation and present what we're doing?

Mr. Gastinger – There's only one Certificate of Appropriateness.

Applicant #2 – How do we know when we're going to come back and present the details when we have spent \$10,000 and you say 'no?'

Mr. Owens – They are not going to say 'no.' They're going to have a different dynamic on the Board that could say 'no.'

Mr. Schwarz – What is your timeline? Are you in a hurry to do this? Could it be postponed a month for you to come back and we have more members present?

Mr. Owens – I don't think there is any hurry other than the wasted effort in that intervening time. We're hoping to come out of here with some kind of agreed opinion from all of you. We can go back to the donor and see if there is still interest. The donation, as I understand it, is maximizing the solar output of the church that gets as close to zero as possible. I understand the concerns. I wish we had split it. That would be the most practical solution. I wish the roofer was here and tell you how he is going to do it. We're stuck here with what we're allowed to do.

Mr. Schwarz – You don't necessarily need to do the homework in the next month. If you can put the expense of doing any design work and figuring out if you can postpone that until we have a more complete Board. That might give you a little more assurance.

Alex Joyner, Pastor – One of our hopes and the donor's hope is that this could be an encouragement to other people in the congregation and to people in the city to consider solar energy to do what the city has said that it wants to do, which is environmental care. It matches the congregation's values and the city's values. I am sure you're going to be getting more requests for solar panels. I realize that we are at forefront of that. It's a question that is not going to go away for you.

Mr. Gastinger – Our guidelines do encourage us to try to find ways to make it work. We just want to make sure you don't end up in a bind. We can put the motion. I don't think it would pass this evening. If we deny it, it can be appealed directly to City Council. Another option is we defer it. It would be on next month's meeting agenda. You can request a deferral which gives you the option of coming back at your convenience.

Motion – Mr. Bailey - Having considered the standards set forth within the City Code, including the ADC District Design Guidelines, I move to find the proposed roof-top solar panels at 101 East Jefferson Street satisfy the BAR's criteria and are compatible with this property and other properties in the North Downtown ADC District, and that the BAR approves the application as submitted.

Whitney, second. Motion failed 2-4.

(Y: Bailey, Whitney. N: Zehmer, Gastinger, Timmerman, Schwarz.)

Applicant requests a deferral – Mr. Schwarz moved to accept for deferral – Mr. Bailey second. Motion approved 6-0.

**City of Charlottesville
Board of Architectural Review
January 18, 2023 - BAR Minutes (draft)**



First United Methodists Church BAR Appeal

Certificate of Appropriateness

BAR # 22-10-02

101 East Jefferson Street, TMP 330190000

North Downtown ADC District (contributing)

Owner: First United Methodist Church

Applicant: William L. Owens, AIA

Project: Install solar panels

Members Present: Ron Bailey, Dave Timmerman, Breck Gastinger, Cheri Lewis, James Zehmer, Carl Schwarz, Roger Birle

Staff Present: Jeff Werner, Mollie Murphy, Patrick Cory, Remy Trail

Jeff Werner - [summarized Staff Report]

William Owens, Applicant – I would like to reiterate that it is important to the church to demonstrate good stewardship of the environment and show that support by supporting sustainable energy. They have been doing a lot of green initiatives at the church. As a result of that, someone has offered a large donation to consider adding solar panels to the church. If they were to do so, they would like to maximize the advantage of that and the coverage of it to reduce their carbon footprint and their electrical bill as much as possible at a savings of close to 50 percent or \$11,000 as proposed. The last time we were here, a major part of our discussion was about the installation, not the panels themselves on a 100 year slate tile roof. We have tried to address that by proposing to remove the tiles underneath the panel arrays and replace them with a water proofing membrane. Right now, it doesn't have anything underneath the tile shingles. Asphalt shingles, which will give it a more typical installation and reduce any concerns there. The panels would cover any kind of roofing in change there. Anything that was remaining would be visible as site shingles. The new roofing would not be seen. The removed shingles would be salvaged and saved. They can be returned and used for repairs or replaced if the panels were removed in the future. The new roofing won't even be seen. The panels themselves would be seen except at a distance. We don't think the panels, since they fall about 6 inches off the roof surface and follow the roofline don't change the characteristic of the historic roof or are detrimental to the character of the historic structure.

QUESTIONS FROM THE BOARD

Mr. Schwarz – Can you reassure me as to what the breakage might be for removing the slate and putting them back? Is that a successful process?

Roofer – It will probably be about 25 percent.

Mr. Bailey – How long do you expect the solar panels to last?

Solar Installer – The warranties are 25 years. They are expected to last anywhere from 35 to 50 years. They become technologically obsolete long before they stop working. There are no moving parts. It is basically a rock on the roof.

Ms. Lewis – What do you do once those are obsolete?

Solar Installer – We really don't see that happening yet. I don't know that the solar industry has a good solution for what to do with all of the panels. They are striving to recycle materials from the panels. Recently, UVA came up with a method to vaporize the silver in the panel.

Ms. Lewis – How sustainable is that when you're talking about replacing materials in 25/30 years?

Solar Installer – That is an excellent question. I don't have a good answer to it.

Mr. Birle – I have a question about the brackets. Would they last more than 25 years?

Solar Installer – Everything is warrantied for 25 years as far as most of the equipment is concerned. The brackets are a piece of aluminum with a stainless steel bolt through them.

Mr. Birle – Once the panels become obsolete, the thought is that you could still have the same framework holding new panels?

Mr. Owens – It is a leg and a track. The panels can be removed and upgraded. Once they have lived their life (technologically or functionally), they can just be replaced. The whole issue with the materials and the recycling is something for the entire industry, not just for our project.

Mr. Bailey – What is the current condition of the slate roof?

Roofer – It is Buckingham slate. It is in pretty good shape

Mr. Timmerman – How old is it?

Mr. Owens – We think it is original to the building. It is close to 100 years old.

Mr. Timmerman – I have a question about the change; getting rid of the slate and putting the new membrane. Was that a result of our feedback? Was that a result of doing a further study on installing these panels on slate?

Mr. Owens – It would probably be both. Much of our conversation was regarding the installation on the slate. Their attempt was to simplify that. We were not able to find

something that really addressed the slate themselves easily. We simplified the geometry of the panel arrays that no longer have steps in them. They can be rectangular roof replacement. It seems to be very common and very easy to install these on an asphalt shingle roof. With the addition of a water proofing membrane and the asphalt shingles, slate is going to be in much worse condition than the roof underneath it. It is protected by the panels themselves from direct rain. There shouldn't be any issue with any kind of leakage long term. It makes it a more typical installation. You never see it. It was a combination of your feedback and finding no other solutions that we thought you would find better than what we came with.

Mr. Birle – How does the membrane meet the existing slate that you're leaving?

Roofer – We build a curb on the sides. We put a copper tap on that and separate the two [?] on the edge of the solar panels. At the bottom, it overlaps.

Mr. Birle – That curb would be the height of the bracket?

Roofer – Yes. It does have to be 3 inches.

Mr. Owens – The track overhangs by up to 3 feet. We would try to place it so that the new roofing stops well within the array.

Mr. Gastinger – I was concerned if you ended up getting too aggressive in removing it and we ended up with a 'halo' around the panel area.

Mr. Owens – The intent would be to keep it as tight as possible to the mounting legs.

Mr. Zehmer – What is the spacing on the mounting legs or anchor points?

Solar Installer – The panels are about 6 feet. There is an overhang on the top. It is probably about 4 feet between rails. There are two rails that support a panel or a row of panels. The spacing is engineered. That goes through a third party.

Mr. Zehmer – A typical asphalt shingle roof is around 25 years.

Roofer – The lifetime of architecture shingles is considered to be 40 to 50 years. They used to make them 25 years.

Mr. Owens – These won't be exposed to the sunlight.

Mr. Zehmer – That's why I was asking about the anchor points. If it is 18 inches or 2 feet, you have to drill a hole through it. That's going to weaken that system.

Mr. Owens – We have to find an engineer. It is 1 by 6 decking. Whether that is adequate enough to support the legs or we have to hit a rafter. The instructions typically say to hit a rafter. It would be easier if we didn't have to do that. If we're allowed to go forward, we will get into those details.

Mr. Zehmer – Where I was going was the concern that the asphalt roof still doesn't outlast the slate around it. You would have to come back and remove those panels to fix that roof.

Ms. Lewis – How many square feet are you removing? What is the area of historic slate?

Solar Installer –It is roughly 4000 square feet.

Mr. Timmerman – This a congregational decision. Do people of the congregation think this is a good idea? Are they very excited about it?

Alex Joyner, Pastor – There is great encouragement and excitement. During the pandemic, we had a justice group that formed that was very interested in green initiatives at the church. When this offer and significant donation came through, that was very encouraging. One of the struggles of every downtown church is being a historic structure and leading the way into something new. This seemed as a way, both to claim our place in downtown but to be a witness. There certainly was a lot of support.

Mr. Owens – This also coincides with the Inflation Reduction Act, which now opens up funding to nonprofits that it didn't before that allows this to be funded in a large part in a way that wasn't available before.

COMMENTS FROM THE BOARD

Mr. Gastinger – I note that while our specific guidelines do not deal with this in detail, we do reference the Secretary of Interior Guidelines. They do provide a number of additional recommendations and guidance.

When I first heard that you were coming back and I heard about the strategy that you were employing, I was very glad to hear that you are not removing all of the slate. I feel that this is a pretty creative way of actually addressing the problem/of dealing with the slate. From my perspective and the way that it has been presented in keeping the new roof under the perimeter of the solar panels, I really don't see how this has any impact on the historic district. I feel this is a supportable direction.

Mr. Birle – I agree. The roof was not visible as I was walking around the church earlier today. You can see the lower roofs from a distance. Given that the [City's] Comprehensive Plan talks about promoting green practices. Our own guidelines say not to discourage sustainable design. I can stand by this.

Mr. Schwarz – I badly want to see solar panels on this project. I can't stand behind it. I really struggle with taking a historic material that has a good long lifetime and removing that, potentially destroying a good portion of it, replacing it with a petroleum product that won't last as long, covering it with solar panels, and it didn't sound like there is a good plan to recycle or replace those solar panels. I am wondering at what point these solar panels actually start being green. There's going to be a long time you're throwing away energy and carbon to

put them up there. Our purview is the historic slate. Telling that 25 percent of that slate is going to be broken in the process, I can't support it unfortunately. I really want to support it.

Mr. Timmerman – From the Secretary of Interior Standards, there is an excerpt under planning. “Forming an integrated sustainability team and working on a large project that includes a preservation professional to ensure the character and integrity of the building is maintained during any upgrade.” I feel that gives a clue to maybe what you're talking about. If there's a way to evaluate the pros and cons, you might have already done that. I hate seeing the most sustainable building material that you can imagine that you pull out of the earth and go back into the earth. Solar panels are a wonderful technology and they are doing a lot of good in the way that it is forming alternates to what we have been using before. There is a beauty and sustainability to doing something very simple. Where is that balance? It is so easy to embrace the new technology because it is new. It appears to be the right thing. I would be interested in knowing if there is a professional assessment out there that really can weigh these sort of issues of these two materials. I am heartened by the comments that you have made about the excitement that the congregation has. We have an ethical need to conserve and be sustainable in this world. I am not going to step in the way of a congregation that has occupied a building for hundreds of years and wants to put a solid step forward in changing things for the better.

Ms. Lewis – We're asked to approve this as a certificate of appropriateness and say that it meets our ADC Guidelines. That's the limited purview of this Board: to weigh sustainability efforts versus the renewal energy system that you want to put on there. That's not in our purview. Even meeting the Comprehensive Plan goals, zoning ordinance encouragement, and Future Land Use Map goals is not part of our purview. Our purview is very narrow here. Our guidelines have not been updated. The city doesn't have the money in engaging a professional preservationist/consulting group who could rewrite our guidelines. We are bound by them. Our guidelines say two things. One is that we cannot install mechanical or service equipment that would damage or obscure a character defining feature of this property. I do think this roof is visible from public rights of way. The slate roof is historic and it is character defining of your beautiful church. Our other guidelines say that you don't remove slate. Slate is historic. It was made nearby. It is so durable. You can't install solar panels on it. Our guidelines are very clear. The other additional standards we can look to for a little bit of guidance are the Secretary of Interior Standards, which have begun to address solar installations. I just want to read those for our reflection and for the applicant hears them. We're bound by this. We don't love this outcome. I really don't think that I have leeway if I am bound to uphold these guidelines. The Secretary of Interior Standards for solar technology:

- Considering onsite solar technology only after implementing all appropriate treatments to improve energy efficiency of the building, which would often have a greater life cycle cost benefit than just the onsite installation of renewable energy.
- Analyzing whether solar technology can be used successfully and will benefit a historic building without compromising its character or the character of the site or the surrounding district.
- Install a solar device in a compatible location on the site or on a non-historic building or addition where it will have minimal impact on the historic building or site.

- Installing a solar device on a historic building only after all other locations have been investigated and determined infeasible.
- Installing a low profile solar device on the historic building so it is not visible or minimally visible from the public right of way or set back to take advantage of a parapet or other feature and to screen panels or on a secondary slope of a roof out of view from the public right of way.

As much as I commend your congregation for wanting to do this, my vote has to be ‘no’ only because of the guidelines that I am supposed to uphold here.

Mr. Zehmer – It is a really creative solution that you came up with. It is a character defining roof, especially over the sanctuary. In our previous meeting, we did talk about looking at the addition roofs. I can see myself supporting solar panels on those roofs. The question becomes: Do we need to tear the slate off those roofs to make them asphalt and solar panel? Would that pass muster? That would probably need another submission/revised submission to have that conversation. Per our guidelines: Place solar collectors and antennae on nonconforming character defining roofs or roofs of non-historic adjacent buildings. I can see a path that way. It is tough for me to approve this seeing them on the main sanctuary roof.

Mr. Bailey – I am extremely conflicted right now. I want it to go forward with this project. Cheri makes a very good point with regard to the standards that we’re supposed to uphold. I really want to support it. I think that I probably cannot support it.

Mr. Gastinger – I thank everybody on the Board for engaging in a debate about a tricky project. We are pulled in different directions. I will say that our guidelines never anticipated this kind of application. The removal of the slate, from what we have been given and what I understand, is that it is actually going to be preserved. It could assist in the long term preservation of the rest of the roof. That preservation of the slate is an important component of this proposal. It would be worth making clearer that if the solar panels were to be removed, it would be replaced with a slate roof to match, presumably with the pieces that were held in storage. I am coming at it from the renderings and the approach. There are two questions before us. Are the solar panels as presented detrimental to the historic district? If they are not, is the removal of the panels going to create any kind of lasting damage to the structure? If there is not, there is no visible indication of a roofing change from what is being proposed. I don’t see how it is detrimental to the historic district. That’s the way I am reading it.

Mr. Birle – Reading from our guidelines. Nothing in these guidelines should be construed to discourage green building or sustainable design. If such a design is found to conflict with a specific guideline, the BAR shall work with the applicant to devise a creative solution that meets the applicant’s goal of sustainability. I feel that is what they have presented. Our offering of a creative solution is really a tough decision.

Mr. Schwarz – In response to the first question: If it was an asphalt roof, I would vote approval. With a 25 percent breakage rate and who knows what is going to happen with that slate in storage for the next 20 years, I don’t believe that they would go back up. That’s unfortunate to not trust the church. At some point, whoever is in charge, the slate is going to

end up being garden markers. The removal of that slate would be condemning that roof to not be slate in the future.

Ms. Lewis – I concur with Mr. Schwarz. It wouldn't say anything about the church. It is human nature. Four thousand square feet of slate does not go back up on that roof once it is removed. I respect the Chair for his analysis. I don't think our analysis is whether the new installation is detrimental to our historic district. The question before us is whether this application complies and can we approve it under our current guidelines? That's our purview. Our purview is not about detriment or harm or future harm. Our guidelines say that you don't remove roofing. You don't harm slate.

Mr. Werner – I did some research. Twenty-five percent is optimistic. The breakage is much higher. When we discussed the roof on the Key Recreation Center, their roofing consultant said 50 percent. It is a difficult decision. The question for the applicant would be a deferral or a denial with an appeal. A deferral would allow additional continued research/discussion. The other perspective is that I am looking at the photo and I am seeing a slate roof a block west of this. In decisions like this, I used to think in terms of land use with a special use permit. When approving something, make sure there is a very small box so it applicable in a very limited way. If there are circumstances that would make this acceptable with a presumption that you're going to see similar requests.

Mr. Owens – With the comments on the slate, we can't change the project as it is in order to accommodate the concerns that the negative votes are going to have. The church is not interested in putting just a hand full of panels on the roof. Unless you have plans to change the guidelines very soon, you're going to get more and more of these requests. You're going to have to address the congregation that is coming from a very good spot to do this. The rest of the world is going to as well. It's not going to be a slate issue. We have to change the way we handle energy. We have to develop it. It is not about the slate coming pretty soon. You are going to have to be prepared to address this. I am in full support of addressing the slate roof and preserving it. There is a conflict coming between some of this stuff and preserving our planet. There's going to have to be a resolution to that. When it comes down to it, we're going to need the energy and not the slate.

Motion – Ms. Lewis - Having considered the standards set forth within the City Code, including the ADC District Design Guidelines, I move to find that the proposed slate roof replacement and roof-top solar panels at 101 East Jefferson Street do not satisfy the BAR's criteria and are not compatible with this property and other properties in the North Downtown ADC District, and that for the following reasons the BAR denies the application as submitted:

- **The removal of the slate and obscuring and damaging the slate does not meet our guidelines.**
- **This proposed system of rooftop installation does not comply with the Secretary of Interior Standards.**

Second by Mr. Schwarz – Motion passes 4-3.

(Yes: Schwarz, Zehmer, Lewis, Bailey. No: Birle, Gastinger, Timmerman.)

From: Bill Owens <wlo3aia@gmail.com>

Sent: Wednesday, August 31, 2022 3:20 PM

To: Werner, Jeffrey B <wernerjb@charlottesville.gov>

Subject: Solar panels for First United Methodist Church

Jeff, First United Methodist Church (101 E. Jefferson St.) is considering adding solar panels to its west sanctuary roof. What is the BAR's view of these, particularly on historical structures? Quickly scanning the design guidelines I didn't see any guidance there. Any different approach than the standard COA application? Any guidance you can give me on behalf of the church would be appreciated. Thank you.

Bill Owens

From: Werner, Jeffrey B <wernerjb@charlottesville.gov>

Sent: Wednesday, August 31, 2022 4:39 PM

To: Bill Owens <wlo3aia@gmail.com>

Subject: RE: Solar panels for First United Methodist Church (1 of 2)

Hey Bill. Quick question: What is your time frame? The BAR will have to review this—it's not complicated, I'll explain in a follow up note in a moment--but if the project is ready to go, I can add it to the September 20 meeting agenda, but we'd have to knock out some paper work tomorrow.

Jeff

From: William (Bill) L. Owens, AIA <bowens@wloarchitect.com>

Sent: Wednesday, August 31, 2022 4:56 PM

To: Werner, Jeffrey B <wernerjb@charlottesville.gov>

Subject: RE: Solar panels for First United Methodist Church (1 of 2)

Jeff, Thanks for the quick response. Attached is what I have in the way of graphics so far, provided by Tiger Solar. Other than the application, this is all I could have by tomorrow, though I'm not sure I could technically get the "owners" signature. If there needs to be more detail, we'll have to wait until the next deadline, which is okay. Thanks.

Bill

From: Werner, Jeffrey B <wernerjb@charlottesville.gov>

Sent: Wednesday, August 31, 2022 6:12 PM

To: Bill Owens <wlo3aia@gmail.com>

Subject: RE: Solar panels for First United Methodist Church (2 of 2)

Bill: Use the attached application. A few changes since 2016, primarily we no longer require hard copies of drawings. The remaining 2022 meetings and the submittal deadlines are below. Drawings can be relatively simple—what parts of the roof will be covered, how will the panels be attached, location and screening of cables and equipment.

You are correct about the design guidelines offering limited direction re: solar panels—and we know that needs to be addressed. Since 2012, we’ve had only six requests for rooftop installations, but the BAR has approved them all. Attached is the staff report from the most recent request and the following link is to a project reviewed last year. Slightly different projects, with one installing panels on the rear of the house and one on the front, but you’ll see how we addressed/applied the design guidelines.

http://weblink.charlottesville.org/public/0/edoc/799318/2021-08_735%20Northwood%20Avenue_BAR.pdf

Obviously—and you know all this, so forgive me--preservation goals suggest that solar panels not obscure or alter historic elements or materials and installed on secondary roofs, if possible. My guess is the BAR will support the panels—mainly because solar panels can be removed, they do not permanently alter the building, and this is a 20th century building, not Monticello—but it’s likely they will prefer them on the north additions, not the primary roof. Wherever they are installed, the other question will be how they impact the slate shingles.

Personally, as an old house owner and from my past construction experience, I’m unconvinced about something that requires *putting holes in a roof*.* So I always advise people that, before adding solar panels, make sure the roof is in good shape and it will be that way for a while. I don’t want to be unfair to the solar companies, but they want to sell panels; the condition of the roof is not their priority. That is, please advise the church to have a crystal clear understanding with the installer about what happens if/when roof repairs are needed.

(* I just looked at how one company installs panels onto slate roofs and I might have to soften my stance a bit. <https://southernlightsolar.com/solar-equipment-products/solar-power-mounting-solutions/solar-power-installations-slate-roofs/>)

Hope that is helpful. Bottom line, I think the BAR will support solar panels, just probably not on the roof of the sanctuary.

Jeff

From: Werner, Jeffrey B <wernerjb@charlottesville.gov>

Sent: Wednesday, August 31, 2022 6:27 PM

To: William (Bill) L. Owens, AIA <bowens@wloarchitect.com>

Subject: RE: Solar panels for First United Methodist Church (#3)

Bill: Image below per my second email. Again, I am only guessing what the BAR might say, and we will have several new members in a month, but at least anticipate they will ask if *everything can go on the back roofs*.

If you get me a signed application and check by tomorrow—there is a drop box near the Market Street entrance to City Hall, see below—we can get this on the Sept 20 agenda. We’ll resolve the drawings later, but I must confirm its an application because the public notice letters go out next Tuesday.

With that, I am done for the day.

Jeff



From: William (Bill) L. Owens, AIA <bowens@wloarchitect.com>
Sent: Thursday, September 1, 2022 3:03 PM
To: Werner, Jeffrey B <wernerjb@charlottesville.gov>
Subject: RE: Solar panels for First United Methodist Church (#3)

Jeff, Thanks for your hustle on this. The church isn't in a big hurry so they don't want me to push to get the application in today. We may aim for the next deadline at the end of the month.

I'm not a solar expert, but it's possible the rear roofs may not have enough area with the correct exposure to accomplish what the church wants. Not having any panels on the sanctuary roof may be a non-starter for them. I suspect they're not going to want to go to the expense of having the system designed only to find out they need to alter it for aesthetic considerations. Is there any way to have some sort of preliminary meeting with the BAR to feel out their thoughts on this ahead of making a formal application so the church has some sense of what direction they need to go?

Thanks.
Bill Owens

From: Werner, Jeffrey B <wernerjb@charlottesville.gov>
Sent: Thursday, September 1, 2022 3:54 PM
To: William (Bill) L. Owens, AIA <bowens@wloarchitect.com>
Subject: RE: Solar panels for First United Methodist Church (#3)

At the Sept 20 meeting, I can informally float this to the BAR and get a sense of any concerns. We can touch base after that and figure out the next steps.

Jeff

From: William (Bill) L. Owens, AIA <bowens@wloarchitect.com>
Sent: Thursday, September 1, 2022 4:49 PM
To: Werner, Jeffrey B <wernerjb@charlottesville.gov>
Subject: RE: Solar panels for First United Methodist Church (#3)

Thank you. Feel free to use the two photos I provided. Please let me know if you need anything further. Thanks.

Bill Owens

From: Werner, Jeffrey B <wernerjb@charlottesville.gov>
Sent: Wednesday, September 7, 2022 5:54 PM
To: William (Bill) L. Owens, AIA <bowens@wloarchitect.com>
Subject: RE: Solar panels for First United Methodist Church (#3)

Bill: Two questions I anticipate from the BAR, if you can help me out.

Is the slate original?

What kind of slate? (relative to life-cycle)

Thanks,

Jeff

From: William (Bill) L. Owens, AIA <bowens@wloarchitect.com>
Sent: Thursday, September 15, 2022 3:28 PM
To: Werner, Jeffrey B <wernerjb@charlottesville.gov>
Subject: RE: Solar panels for First United Methodist Church

Jeff, Sorry for the delay getting back to you. I wanted to contact Martin Roofing who maintains the church's roof to confirm the answers to your questions. Their response was they believe the slate is original to the church and that it is Buckingham Slate.

In the interval, I also met with the church and Tiger Solar to clarify any details of the project. Their desire is to place approximately 220 solar panels on the roof with the goal of making the church close to net-zero for its electrical needs. They are willing to break up the panel arrays or spread the panels over multiple roof surfaces as required to address any visual concerns. The two initial images I provided to you were based on the thought that the two locations shown were the least visible roofs from the street. However, the church is more than willing to consider other or additional roof areas. The important goal is having enough panels to reduce their electrical bill close to zero.

Please let me know if you have any other questions or concerns as you approach the BAR meeting next week. Thanks for your help.

Bill

From: Werner, Jeffrey B <wernerjb@charlottesville.gov>
Sent: Friday, September 16, 2022 8:27 AM
To: William (Bill) L. Owens, AIA <bowens@wloarchitect.com>
Subject: RE: Solar panels for First United Methodist Church

Perfect. Thank you.
Have a great weekend.
Jeff

From: William (Bill) L. Owens, AIA
Sent: Wednesday, September 21, 2022 4:08 PM
To: Werner, Jeffrey B <wernerjb@charlottesville.gov>
Subject: RE: Solar panels for First United Methodist Church

Jeff, Were you able to get any insight or opinions on the solar panels from the BAR last night?
Thanks.
Bill

From: William (Bill) L. Owens, AIA <bowens@wloarchitect.com>
Sent: Friday, September 23, 2022 12:25 PM
To: Werner, Jeffrey B <wernerjb@charlottesville.gov>
Subject: RE: Solar panels for First United Methodist Church

Jeff, I'm trying to get the church's application prepared for Tuesday's submission deadline. Do you have any further guidance from the BAR or should I just go ahead and submit the images you've already seen? Thanks for your help.
Bill

From: Werner, Jeffrey B <wernerjb@charlottesville.gov>
Sent: Friday, September 23, 2022 1:20 PM
To: William (Bill) L. Owens, AIA <bowens@wloarchitect.com>
Subject: RE: Solar panels for First United Methodist Church

Yes. Sorry, been a busy week.

BAR is not opposed to solar panels on the roof, but the questions were more related to the slate roof and how it will fare during installation of the panels and later maintenance/upgrades.

Might be easiest to watch the meeting video, link below. The discussion is from 04:41:00 to 04:52:00. (It was a long night and my exhaustion shows.)

<https://boxcast.tv/channel/vabajtzezyv3iclkx1a?b=nvdouryu5aooH1orqwxd>

Jeff

From: William (Bill) L. Owens, AIA <bowens@wloarchitect.com>

Sent: Tuesday, September 27, 2022 3:41 PM

To: Werner, Jeffrey B <wernerjb@charlottesville.gov>

Subject: RE: Solar panels for First United Methodist Church

Jeff, Confirming you received the BAR application and fee yesterday. Submittal documents to follow shortly. Thank you.

Bill Owens

From: Werner, Jeffrey B

Sent: Tuesday, September 27, 2022 3:57 PM

To: William (Bill) L. Owens, AIA <bowens@wloarchitect.com>

Subject: RE: Solar panels for First United Methodist Church

Got it.

Jeff

From: Werner, Jeffrey B

Sent: Monday, October 17, 2022 3:24 PM

To: William (Bill) L. Owens, AIA <bowens@wloarchitect.com>

Subject: RE: BAR Packet for Oct 18 (FUMC)

I've got you my list with three others. Currently we have 15 requests to attend in-person. That accounts for all but two I expected to hear from, so we should be OK.

If tomorrow we hit the limit, I might ask you to choose only one or two to join you, but we'll see what happens.

By the way, I talked about your project with a friend involved in commercial-scale alt energy. Told him my concern was less about the historic building, but almost entirely the impact of [non-roofer] work activity on a slate roof and the unknown costs that might follow. He agreed most solar companies just want to sell panels, and aren't worried about the long-term integrity of the roofs under them. (I don't mean to disparage anyone, but it's a question I have yet to hear fully answered: When the roof leaks or needs to be replaced, who pays to remove and reset the solar panels?) He suggested the congregation weigh all opportunities—and costs—to achieve their goals, and that might include off-site options that avoid the roof uncertainties—and costs. Obviously, Dominion Power has a program, but he suggested contacting Solar United Neighbor (www.solarunitedneighbors.org/virginia/).

I support solar power, but I can't escape a lesson from 25 years ago when I worked at UVa Facilities Management. I was tasked with coordinating the installation of solar panel at the A-School. The FM director—a retired Army colonel--told me to make it work, that he fully supported the concept. However, he then added this very stern order: *Unless Bill McDonough*

*agrees to repair any leaks, you will **not put any holes in my roof**.* (And now you know why there are no solar panels on Campbell Hall.)

Jeff

From: Werner, Jeffrey B <wernerjb@charlottesville.gov>
Sent: Thursday, October 20, 2022 12:05 PM
To: William (Bill) L. Owens, AIA <bowens@wloarchitect.com>
Subject: BAR Meeting 10-18-2022

Link to the meeting video. FUMC discussion starts at 02:08:00.
<https://boxcast.tv/channel/vabajtzezuYv3iclkx1a?b=uzjzabhfohchjty5hs6f>

From: William (Bill) L. Owens, AIA <bowens@wloarchitect.com>
Sent: Tuesday, October 25, 2022 5:31 PM
To: Werner, Jeffrey B <wernerjb@charlottesville.gov>
Subject: RE: BAR Meeting 10-18-2022
Jeff, Thanks for your guidance thru the BAR process thus far.

Given that both the church's roofer and solar contractor are on vacation the next couple of weeks, it's extremely unlikely we'll have any new information to resubmit in time for the BAR meeting in November. The church isn't in any rush, so they're going to take the deferral last Tuesday as an opportunity to step back and reevaluate the project as a whole, including both the installation approach for the existing slate roof and the provider of the solar panels. As you may have been able to tell, I was disappointed that neither the roofer nor the solar contractor made themselves available to attend the meeting. I think their participation could have addressed some of the board's concerns and potentially prevented the need for a subsequent return. The church is still interested at this point in pursuing the project, but I think having refined details for the December or January meeting is more realistic.

In the meantime, so I can assist the church with their decision making, can you tell me how each board member voted last Tuesday and their contact information along with information on any board member who wasn't there? (Or if it exists somewhere, direct me to where I can find it?) As suggested, we may reach out to those who are potential "no" votes in the future to address their concerns individually as our details evolve. And I suppose that if we find there just isn't enough board support to approve the project, the church may defer the idea indefinitely.

Thanks again for your help.

Bill

From: Werner, Jeffrey B <wernerjb@charlottesville.gov>
Sent: Wednesday, October 26, 2022 12:59 PM

To: William (Bill) L. Owens, AIA <bowens@wloarchitect.com>
Subject: RE: BAR Meeting 10-18-2022

Bill. List below of the BAR members and email addresses. (We are short one member until Council makes an appointment.) Highlighted yellow are the six who were present for the Oct 18 discussion.

The motion to approve the CoA failed with a 2 – 4 vote.

Yes (to *approve* the CoA): Ronald Bailey, Tyler Whitney

No (to *not approve* the CoA): James Zehmer, Breck Gastinger, David Timmerman, Carl Schwarz.

[...]

Also, I have asked my colleagues in other localities how they have treated panels on slate roofs. One reply so far, from Alexandria:

We haven't had any requests for panels on a slate roof, so have not yet had to address the thorny issue of installation.

We recently created criteria for administrative/staff approvals.

Mounted directly to the roof slope.

Located on later buildings (constructed after 1932).

If the roof will be replaced, an architecturally compatible and appropriate color replacement material should be used so that the solar panels visually blend-in with the roof.

Recommendation that roofing be replaced prior to [solar panel] installation, so that the panels do not have to be removed and reinstalled a short time later.

Any installation that does not meet the foregoing criteria must go to a full hearing of the BAR.

Jeff

From: William (Bill) L. Owens, AIA <bowens@wloarchitect.com>

Sent: Monday, December 5, 2022 5:53 PM

To: Werner, Jeffrey B <wernerjb@charlottesville.gov>

Subject: RE: BAR Meeting 10-18-2022

Jeff, The church has met with Martin Roofing and Tiger Solar following the BAR meeting and has come up with more practical approach to their solar panel project. They would like to get on the agenda for the January 18th BAR meeting. What is involved with this? Do I need to submit a new application, or since this was a deferral, just request the original application be reinstated?

Thanks for the help.

Bill

From: Werner, Jeffrey B <wernerjb@charlottesville.gov>
Sent: Tuesday, December 6, 2022 8:55 AM
To: William (Bill) L. Owens, AIA <bowens@wloarchitect.com>
Subject: RE: BAR Meeting 10-18-2022

Send me what you have. A new application isn't necessary. We'll just call it the *FUMC Solar Project*.

Jeff

From: William (Bill) L. Owens, AIA <bowens@wloarchitect.com>
Sent: Wednesday, December 14, 2022 10:49 AM
To: Werner, Jeffrey B <wernerjb@charlottesville.gov>
Subject: RE: BAR Meeting 10-18-2022

Jeff, I just received a Zoom invitation for next Tuesday's BAR meeting. You don't happen to know why? I had asked for the church to be on the agenda for the January 18th meeting. I don't have all my new materials together for you yet. Thanks.

Bill Owens

From: Werner, Jeffrey B <wernerjb@charlottesville.gov>
Sent: Wednesday, December 14, 2022 11:28 AM
To: William (Bill) L. Owens, AIA <bowens@wloarchitect.com>
Subject: RE: BAR Meeting 10-18-2022

Not sure what happened, but you can ignore that.

You are set for Jan 18 meeting

Jeff

CITY OF CHARLOTTESVILLE, VIRGINIA
CITY COUNCIL AGENDA



Agenda Date:	March 20, 2023
Action Required:	Public Hearing
Presenter:	Michael Rogers, City Manager
Staff Contacts:	Krisy Hammill, Director of Budget
Title:	Proposed real estate tax rate for the FY 2024 City Manager's Proposed Budget

Background

The Council meeting on March 20, 2023 marks the first public hearing on the proposed real estate tax rate for the FY 2024 City Manager's Proposed Budget. The Interim City Manager will give a very quick overview of the budget prior to the public hearings. A legal ad was published, as required, in the Daily Progress on February 14, 2023 (real estate tax levy). A copy of the ad is also posted on the FY 2024 Budget Development section of the following website: www.charlottesville.gov/budget.

Discussion

The Equalized Tax Rate is \$0.8589/\$100 of assessed value. (This rate is calculated as the rate of tax that would need to be applied to the current [increased] property assessments, in order to generate the same amount of tax revenues as in Tax Year 2022). For purposes of the budget, the equalized rate of \$0.8589/\$100 is the calculated rate that will keep the City's revenue from real estate taxes equal with last year. Although this is a lower rate, it is still possible that some individuals could see an increased tax bill solely on the basis of their individual reassessment. The proposed tax rate that has been advertised is \$0.96/ \$100, which is \$0.1011 higher than the equalized rate of \$0.8589/\$100. For FY 24, real estate tax revenue is budgeted to generate \$9,915,424 in new revenue over FY 23 based on the advertised tax rate of \$0.96/\$100 and the 2022 assessed values.

Alignment with City Council's Vision and Strategic Plan

The City Manager's Proposed Budget aligns with Council's Vision and FY 2018 – 2020 Strategic Plan which has been extended to 2024 and is detailed in the budget document.

Community Engagement

There are several remaining opportunities for the community to provide input into the budget. In addition, a few minutes are reserved at the end of each Budget Work session for public comment and input. The proposed budget document and materials for the budget work sessions are posted at www.charlottesville.gov/budget.

Budgetary Impact

The FY 24 Proposed Budget is balanced using a real estate tax rate of \$0.96/\$100. Should City Council decide to change the rate, expenditures would have to be adjusted (up or down) to reflect the amount of revenue that would result from a different tax rate.

Recommendation

Staff recommends that City Council, after completing the public hearing process, determine whether the proposed budget contains sufficient funds for the various operational needs and priority projects that City Council wishes the City government to undertake in FY2024. If not, see “Alternatives”, below.

Alternatives

To the extent that City Council is willing to adjust the Real Estate Tax rate, City Council may—following the 3/22/2023 Budget Public Hearing—insert new items of expenditures or may increase, decrease or strike out items of expenditures.

Attachments

None

CITY OF CHARLOTTESVILLE, VIRGINIA
CITY COUNCIL AGENDA



Agenda Date:	March 20, 2023
Action Required:	Approve Resolution (1 reading - Public Hearing)
Presenter:	Brenda Kelley, Redevelopment Manager
Staff Contacts:	Samuel Sanders, Jr., Deputy City Manager Brenda Kelley, Redevelopment Manager
Title:	Approving Lease Agreement with Albemarle Charlottesville Historical Society for lease of 200 Second Street NE (1 reading)

Background

The City of Charlottesville and Albemarle County Historical Society d/b/a Albemarle Charlottesville Historical Society (“Historical Society” or “Tenant”) first entered into a lease agreement in January 1993 for lease of the McIntire Library Building at 200 Second Street NE. Following renovations, the Historical Society moved into the building in 1994. This building was formerly home to the Jefferson Madison Regional Library. The library continues to sublease a small portion of the building from the Historical Society.

The most recent Lease Agreement with the Historical Society was effective for three years (from May 1, 2019 through April 30, 2022) with two, one-year extensions, in writing. The City issued an Addendum in May 2022, which extended the lease term only until April 30, 2023, with no renewals after the term expires.

Discussion

The Historical Society, a nonprofit organization, has two full-time and two part-time employees and a full-time research librarian who is an employee of Jefferson Madison Regional Library. They also have approximately 30 active volunteers and report that that number is growing.

Information about the Albemarle Charlottesville Historical Society, including non-profit 501(c)(3) status and IRS Form 990 information can be found at:

<https://albemarlehstory.org/>

City staff provides the following information relative to this lease approval request:

Building space (square footage):	3,218
Assessed Value:	\$2,096,000.00
Current Lease Rate:	\$826.88/month (\$9,922.56/annual)
Current Lease Rate per square foot:	\$3.08 +/-
Potential Annual Lease Value:	\$15-20 / SF \$4,022 - \$5,363 / month

Comparable Fair Market Rent Value: \$56,310.00
Comparable Market Rent (per square foot):
(NAR Commercial Real Estate Metro Market Report, Q1/2022 for Charlottesville, VA)
Office: \$24.7
Retail: \$20.6

The general terms of the Lease Agreement are:

Lease period: 5 years (expires April 30, 2027)
Lease rate: \$851.68/month, with no more than 3% annual increase
(\$10,220.16/annual)
Security Deposit: \$1703.36
Tenant Responsibilities: grass mowing; grounds maintenance; maintenance of exterior light fixtures; janitorial services; cost of utilities, insurance; Tenant accepts Premises "as-is"
City Responsibilities: maintenance of structural elements and systems

Alignment with City Council's Vision and Strategic Plan

The provision supports City Council's visions of Economic Sustainability; and C'ville Arts & Culture. This program aligns directly with Strategic Plan Goal 3.5: Protect historic and cultural resources; Goal 4.2 Attract and cultivate a variety of businesses; and Goal 4.4 Promote tourism through effective marketing.

This program also supports the 2021 Comprehensive Plan's:

Guiding Principle: Community Culture & Unity: Charlottesville's rich and diverse culture and form will be celebrated, and the entire community will feel welcomed, valued, and respected. The City will protect, celebrate, and enhance the people and places that have added to the uniqueness and cultural diversity of the community.

Land Use, Urban Form, and Historic & Cultural Preservation; Goal 11. Historic Resource Protection: Provide effective protection of Charlottesville's historic resources, including through recognition and incentives.

Community Engagement

This Lease Agreement has been reviewed by Albemarle Charlottesville Historical Society representative(s).

Budgetary Impact

This request does not require any funding from the City budget. It is assumed that maintenance costs may be offset by rent payments.

Recommendation

Staff recommends that City Council approve the attached Resolution following Public Hearing.

Alternatives

City Council could choose to not approve this Resolution which will result in the current lease Addendum to expire. The terms of the lease Addendum specifically states that the terms may not be renewed through additional addendum after this current extension period expires.

Attachments

1. Resolution Historical Society Lease Agreement 032023
2. Albemarle County Historical Society Lease revdraft022823

RESOLUTION

Approving a lease of property at 200 Second Street, NE to the Albemarle Charlottesville Historical Society

WHEREAS, the Albemarle County Historical Society d/b/a Albemarle Charlottesville Historical Society desires to lease certain City-owned property for a term of five (5) years, and City Council has considered the terms of the proposed lease, and has conducted a public hearing in accordance with the requirements of Virginia Code Sec. 15.2-1800(B); NOW, THEREFORE,

BE IT RESOLVED by the Council of the City of Charlottesville, Virginia, that the lease of City-owned property located at 200 Second Street, NE, Charlottesville, Virginia, to the Albemarle County Historical Society d/b/a Albemarle Charlottesville Historical Society, presented to Council this same date for consideration, is hereby APPROVED and the City Manager is hereby authorized to execute the approved lease on behalf of City Council.

Approved by Council
March 20, 2023

Kyna Thomas, CMC
Clerk of Council

CITY OF CHARLOTTESVILLE LEASE AGREEMENT

(City-owned building)

THIS LEASE AGREEMENT (hereinafter, “Lease” or “Lease Agreement”) is made and entered into this ____ day of _____, 20____, by and between THE CITY OF CHARLOTTESVILLE, VIRGINIA, a Virginia municipal corporation, herein referred to as “Landlord,” and ALBEMARLE COUNTY HISTORICAL SOCIETY, a Virginia non-profit, non-stock corporation organized and operating under the laws of the Commonwealth of Virginia d/b/a the ALBEMARLE CHARLOTTESVILLE HISTORICAL SOCIETY herein referred to as “Tenant”.

WITNESSETH:

ARTICLE I. DEMISED PREMISES

- A. For and in consideration of the payment by Tenant of the rent hereinafter reserved and the performance by Tenant of the covenants and agreements hereinafter agreed to be performed by it, in accordance with all of the provisions hereinafter set forth, Landlord does hereby lease, let, and demise unto Tenant, its successors and assigns, and Tenant does hereby take, lease and hire from Landlord, a building, and land and various appurtenances thereto pertaining, located at **200 Second Street, NE, Charlottesville, Virginia** (the “Property”), the premises subject to this Lease being as more particularly described within **Exhibit A**, attached and incorporated herein by reference (collectively, the “Demised Premises”).
- B. Tenant acknowledges that it has had an opportunity to inspect the Demised Premises, and that the Demised Premises are in good order and repair, unless otherwise indicated within a written Inspection Report attached to this Lease Agreement as **Exhibit D**, and signed by both Landlord and Tenant. Tenant accepts the Demised Premises “as-is”. Tenant acknowledges that, based on its own inspection of the Demised Premises, the Demised Premises are suitable for its intended purposes. Landlord makes no warranties or representations as to the suitability of the Demised Premises for Tenant’s intended purposes.

ARTICLE II. TERM

The term of this Lease shall be for a period of five (5) years (“Term”), commencing on the 1st day of May, 2023 (“Commencement Date”), and expiring at midnight on the 30th day of April, 2027 (“Expiration Date”) unless sooner terminated by the parties in accordance with this Lease.

By written request submitted to the Landlord at least ninety (90) days in advance of the Expiration Date, Tenant may request a lease agreement for an additional term of years. Upon receipt of Tenant's request, the City's Representative will prepare a new lease document and, upon confirmation by the Tenant that the terms of the new lease document are satisfactory, the proposed lease for a new term of years shall be presented to City Council or a City official to whom City Council has delegated authorization to grant such approval.

ARTICLE III. COMMON AREAS AND PARKING

The Landlord agrees that Tenant and Tenant's customers, employees, and/or visitors, shall have the right throughout the Term of this Lease to use, in common with others entitled to similar use thereof, all of the interior common areas of the Property of which the Demised Premises are a part, including (i) all hallways, stairways, and doorways for ingress to and egress from the Demised Premises, and (ii) exterior common areas such as onsite parking spaces, walkways located on the Property, driveways, alleys, and any other means of ingress to and egress from the Demised Premises, as applicable. Maintenance of the Common Areas shall be as set forth in Article XIII.

ARTICLE IV. USE OF DEMISED PREMISES

- A. **Tenant to maintain ongoing business.** The Tenant shall occupy Demised Premises throughout the Term of this Lease and shall conduct an ongoing business (whether for-profit or not-for-profit) throughout the entire term. Failure to maintain an ongoing business, except for shutdown for reasonable vacations of no more than one month per year, shall be deemed a breach of this Lease. Tenant shall pay all business license taxes and business personal property taxes which may be imposed by the Commonwealth of Virginia or the City of Charlottesville.
- B. **Specific uses authorized.** The Demised Premises shall be used by the Tenant primarily as a historical educational center, which may include any of the following uses or activities, as defined in the City's zoning ordinance: "library", "non-profit", "general office" or "meeting space". Tenant may sublease spaces within the Demised Premises to others engaged in such uses ("subtenants"), subject to all the same terms and conditions, but no sublease shall extend beyond the term of this Lease. No other use or sublease may be made of the Demised Premises without the advance and express written consent of the Landlord. Landlord acknowledges that a portion of the building basement has been sublet by the Jefferson Madison Regional Library (JMRL). Tenant shall be required to provide the Landlord evidence of comprehensive public liability and worker's compensation insurance coverage for JMRL. Tenant shall submit evidence of such insurance coverage, via a certificate of insurance issued, for approval prior to the commencement date of this lease and within 10 days of the renewal of such coverage. Tenant shall provide the Landlord with a copy of the current sublease with JMRL upon the Landlord's request.
- C. **Rules and regulations.** Tenant agrees to observe all reasonable rules and regulations from time to time promulgated by Landlord, which in the Landlord's judgment (to be reasonably exercised) are needed for the general well-being, safety, care and cleanliness of the Demised Premises and the Property of which they are a part; provided, however, that any such rules and regulations shall be of general application to all other tenants and occupants of said Property. Such rules and regulations are incorporated herein as if fully set forth. A breach of a rule or regulation shall constitute a breach of this Lease. The rules and

regulations may, in the sole discretion of the Landlord, be modified from time to time, so long as they do not affect a material change in this Lease. Such rules shall include, but are not limited to, the following:

- 1) The sidewalks, entries, passages, elevators, public corridors and staircases and other parts of the Property which are not occupied by the Tenant shall not be obstructed or used for any other purpose other than ingress and egress.
- 2) The Tenant shall not install or permit the installation of any awnings, shades, and the like, other than those approved by the Landlord in writing.
- 3) No additional locks shall be placed upon any doors in the Demised Premises unless keys therefor are given to the Landlord for use in emergencies; and the doors leading to corridors or main halls shall be kept closed during business hours except as they may be used for ingress and egress.
- 4) Tenant shall not construct, maintain, use or operate within the Demised Premises (or elsewhere in the Property of which said Demised Premises form a part, or on the outside of the Demised Premises) any equipment or machinery which produces music, sound or noise which is audible beyond the Property, unless otherwise permitted by event approval.
- 5) Electric, cable and telephone floor distribution boxes must remain accessible at all times.
- 6) No animals shall be kept by Tenant in or about the Leased Premises and the Tenant shall not suffer any animal(s) to be kept in or about the Leased Premises. Service animals shall be permitted.
- 7) No vehicles of any kind, including but not limited to electric scooters, shall be brought into the lobby or elevators of the Property or into the Demised Premises. Bicycles shall not be left stored in any common areas or within any other area that could obstruct free egress during an emergency.
- 8) Tenant shall not utilize in the Demised Premises equipment requiring electrical energy other than ordinary office equipment (including desktop computers, telephones, fax machines, copying, printing and scanning equipment). All industry, electrical and City/State codes must be complied with at all times for use of any equipment.
- 9) Tenant shall comply with the "Facility Terms of Use; Facility Site Use and Maintenance Definitions and Facilities Operations and Maintenance" established by Landlord, attached hereto as **Exhibit B**, and incorporated by reference, as such document may be modified by Landlord from time to time. In the event of a conflict between any provision of this Lease and the contents of **Exhibit B**, and any future modification thereof, the provision most favorable to the Landlord shall govern.

ARTICLE V. RENT

- A. **Basic monthly rent.** The Tenant hereby covenants and agrees to occupy the Demised Premises as Tenant of the Landlord for the term hereinabove set forth, and agrees to pay to the Landlord rental therefor without offset or deduction therefrom, the sum of ten thousand two hundred twenty dollars and sixteen cents (\$10,220.16) in U.S. currency, **per year ("basic annual rent")**, payable in monthly installments (hereinafter referred to as the "Basic Monthly Rent").

The Basic Monthly Rent estimated to be due is eight hundred fifty-one dollars and sixty-eight cents (\$851.68), payable on the 1st day of May, 2023 and the first day of each calendar month thereafter throughout the Term of this Lease.

Rent payments shall be delivered by check, cash or wire transfer to:

Mail Check:

Office of the City Manager
City of Charlottesville
P.O. Box 911
Charlottesville, VA 22902
Attn: Lease – Albemarle Charlottesville Historical Society

In Person (cash or check):

City of Charlottesville
Customer Service, 1st Floor
600 E. Main Street
Charlottesville, VA 22902
Attn: Lease – Albemarle Charlottesville Historical Society

Wire Transfer:

Information provided upon request.

Tenant is responsible for ensuring that payment is received by the City by the Due Date.

The Fair Market Rent for the Demised Premises is \$56,310.00. The difference between the basic annual rent and the Fair Market Rent is at least \$46,089.84 annually, which shall be deemed an in-kind financial contribution by Landlord to Tenant.

B. Adjustment in basic annual rent. The basic annual rent shall be subject to automatic adjustment for increases as follows: At the end of the first year (twelve (12) months) during the term of this Lease, and thereafter at the end of each succeeding year, and effective simultaneously with the date of each such adjustment, the basic annual rent (and the Basic Monthly Rent installments thereof) shall be adjusted by no more than three percent (3%) per annum of the basic annual rent for the immediate preceding year.

C. Additional Rent-

- 1) **Taxes.** During the term of this Lease, Tenant shall be solely responsible for, and shall pay to the City, in addition to the basic annual rental as aforesaid, as additional rent, any real estate taxes and assessments imposed on its leasehold interest, and Tenant's Proportionate Share of any stormwater utility fees.
- 2) **Tenant's Proportionate Share.** "Tenant's Proportionate Share" means a percentage determined by dividing the square footage of the Demised Premises by the total square footage of rentable space available on the Property.
- 3) **Reconciliation of Additional Rent.** After the end of each calendar year or partial calendar year during the Term, Landlord shall deliver to Tenant a report setting

forth the actual amount of Additional Rent that is by Tenant payable for such calendar year.

ARTICLE VI. LATE CHARGES; INTEREST

- A. *Late Charges.* Tenant shall pay Landlord a late charge equal to five percent (5%) per month or any portion of a month, of the amount of rent which was not paid when due.
- B. *Interest.* Any payment other than rent due from Tenant to Landlord which is not paid when due shall bear interest from the date due until the date paid at the prevailing prime rate of interest (defined as the base rate on corporate loans posted by at least one percent (1%) per month), beginning on the due date and continuing until paid.

ARTICLE VII. SECURITY DEPOSIT

Concurrently with Tenant's execution of this Lease, Tenant shall deposit with Landlord an amount equal to \$1,703.36 as security for damage due to Tenant's failure to pay sums due hereunder, misuse of the Demised Premises, etc. (hereinafter, the "Security Deposit"). Landlord shall not be required to pay interest on the Security Deposit or to maintain it in a separate account. Within three (3) days after written notice of Landlord's use of the Security Deposit, Tenant shall deposit with Landlord cash in an amount sufficient to restore the Security Deposit to its prior amount. Within ninety (90) days after (a) the expiration or earlier termination of the Lease Term, or (b) Tenant's vacating the Demised Premises, Landlord shall return the Security Deposit less such portion thereof as Landlord may have used to satisfy Tenant's obligations. If Landlord transfers the Security Deposit to a transferee of the Lease or Landlord's interest therein, then such transferee (and not Landlord) shall be liable for its return. The holder of any Mortgage shall not be liable for the return of the Security Deposit unless such holder actually receives the Security Deposit.

ARTICLE VIII. DAMAGE OR DESTRUCTION BY CASUALTY

- A. *Casualty renders entirely untenable.* If during the term of this Lease, the Demised Premises are damaged by fires, floods, windstorms, earthquakes, explosions, hurricanes, tornadoes, strikes, acts of public enemy, incidences of terrorism, wars or riots, civil disturbances, acts of God, or other casualty, so that the same are rendered untenable, or unsuitable for Tenant's uses, and if said Demised Premises cannot be repaired by Landlord within ninety (90) days from the time of said damage, then this Lease shall terminate as of the date of such damage. In such case, Tenant shall pay the rent apportioned to the time of damage and shall immediately surrender the Demised Premises to Landlord who may enter upon and repossess the same and Tenant shall be relieved from further liability hereunder.
- B. *Casualty renders partially untenable.* If said Demised Premises shall be partially damaged by any of the above casualties as to be partially untenable, or partially unsuitable for Tenant's uses, Landlord shall repair the Demised Premises promptly and during the period from the date of such damage until the repairs are completed, the rent shall be apportioned so that Tenant shall pay as rent an amount which bears the same ratio to the entire monthly rent as the portion of the Demised Premises which Tenant is able to occupy during such period bears to the entire area of the Demised Premises. If the damage by any of the above casualties is so slight that Tenant is not disturbed in his possession and

enjoyment of the Demised Premises, then Landlord shall repair the same promptly and in that case the rent accrued or accruing shall not abate.

- C. *Exclusions from Landlord's repairs.* If Landlord undertakes repair of the Demised Premises under this Section, Landlord shall not be obligated to repair, restore or replace any of Tenant's furniture, fixtures or any other personal property owned by or in the possession of Tenant, and Landlord shall not be under any obligation to repair, restore or replace any alterations to the Demised Premises made by or on behalf of Tenant.
- D. *No diminution of rent for inconvenience.* No compensation or claim or diminution of rent will be allowed or paid by Landlord by reason of inconvenience, annoyance, or injury to business arising from the necessity of repairing the Demised Premises or any portion of the real estate of which the Demised Premises are a part, however the necessity may occur. Tenant understands and agrees that for this reason it is the Tenant's sole responsibility to obtain adequate insurance available to protect its interest in the event of such a casualty.
- E. *Termination if repairs are prohibited by law.* Notwithstanding any provision of this Lease to the contrary, Landlord may terminate this Lease in the event any local ordinance, or any state or federal statute or regulation, prohibits or inhibits any rebuilding, restoration or repair of the Demised Premises. Landlord shall deliver such written notice of termination to Tenant within thirty (30) calendar days after the event causing damage or casualty.
- F. *Termination if Landlord's insurance proceeds are inadequate.* Notwithstanding any provision of this Lease to the contrary, Landlord may terminate this Lease in the event that Landlord's insurance coverage fails to cover the event causing the damage or casualty and/or the costs of rebuilding, restoring or repairing the Demised Premises. Landlord shall provide to Tenant a copy of the determination from the insurance company within fifteen (15) calendar days after receipt of the notice of denial of coverage.
- G. *Landlord's Option to Terminate and Not to Restore.* Notwithstanding any provisions of this to the contrary, if there is substantial damage to the Demised Premises due to a fire or other casualty, then Landlord may elect to terminate this Lease, by delivering written notice of such termination to Tenant, within thirty (30) days of such casualty, the notice to specify a termination date of not less than thirty (30) days after its transmission.
- H. *Mutual Right to Terminate.* Notwithstanding anything herein to the contrary, if the Demised Premises are damaged by casualty during the last six (6) months of the Lease Term, Landlord and Tenant shall each have the right to terminate this Lease by giving the other notice within thirty (30) days of such casualty.

ARTICLE IX. FORCE MAJEURE

- A. *Effect of Events of Force Majeure.* Except as otherwise expressly set forth herein, in the event either Landlord or Tenant shall be delayed or hindered in, or prevented from, the performance of any act or rendering of any service required under this Lease, by reason of strikes, inability to obtain materials, failure of power or other utilities, restrictive governmental laws or regulations, acts of God, incidences of terrorism, wars or riots, civil disturbances, floods, earthquakes, volcanic activity, fire, explosions, epidemics, hurricanes, tornadoes, or other reasons of a similar or dissimilar nature which are beyond the reasonable control of the Landlord or Tenant (collectively known as "Event"), then the performance of any such act or rendering of any such service shall be excused for the period of the resulting delay and the period of the performance or the rendering of the service shall be extended for a period equivalent to the period of such delay. Notwithstanding the

foregoing, this paragraph shall not be applied so as to excuse or delay payment of any monies by one party to the other, including any rent.

- B. Except as specifically contained herein or unless otherwise expressly provided in this Lease, nothing contained in this Article shall be applied so as to: (a) permit any delay or time extension due to shortage of funds; or (b) excuse any nonpayment or delay in the payment of rent; or (c) limit either the Landlord's or the Tenant's rights under this Lease to cure the other party's default.
- C. It shall be a condition to either party's claim of the benefit of this Article, that such party seeking the benefit of this Article give notice to the other party in accordance with Article XXVI within twenty-four (24) hours after the occurrence of any Event, and within forty-eight (48) hours after request shall advise the other party in writing of its good faith estimate of the time required until the delay is ended. The party seeking the benefit of this Article shall have no liability to the other party in the event the good faith estimates of the time needed to cure the delay is not met, however, the party seeking the benefit of this Article shall advise the other party in writing whenever such party learns that the additional time may be required to cure the delay. Upon the request of the other party, the party seeking the benefit of this Article shall advise the other party as to the latest estimate of time needed to cure the delay, and the actions being taken to cure the delay. In case of interruption of all methods of giving notice set forth in this Article, notice shall be deemed given on the second day of reasonably prominent news coverage of the Event reasonably able to be recognized as affecting the Demised Premises.

ARTICLE X. INSURANCE

- A. *Required insurance coverage.* Tenant shall maintain throughout the term, with a company licensed to do business in the Commonwealth of Virginia, approved by the Landlord, and having a rating satisfactory to Landlord: (a) broad form comprehensive general liability insurance (written on an occurrence basis, including contractual liability coverage insuring the obligations assumed by Tenant pursuant to the following paragraph entitled "Indemnification of Landlord," and an endorsement for personal injury), (b) all risk property insurance, and (c) comprehensive automobile liability insurance (covering automobiles owned by Tenant).
 - 1) The broad form comprehensive general liability insurance shall be in the minimum amount typically carried by prudent tenants engaged in similar operations, but in no event shall be in an amount less than one million Dollars (\$1,000,000) combined single limit per occurrence, including a minimum limit of \$100,000 Fire Damage Legal.
 - 2) Tenant's property insurance shall be in an amount not less than that required to replace all fixtures, betterments and improvements and other contents located on the Demised Premises.
 - 3) Tenant's automobile liability insurance shall be in an amount not less than One million Dollars (\$1,000,000).

Landlord reserves the right from time to time to require Tenant to obtain higher minimum amounts of insurance.

- B. All such insurance shall name Landlord as an additional named insured, contain an endorsement that such insurance shall remain in full force and effect notwithstanding that the insured may have waived its claim against any person prior to the occurrence of a loss,

provide that the insurer waives all right of recovery by way of subrogation against Landlord, its partners, agents and employees, and, contain an endorsement prohibiting cancellation, failure to renew, reduction in amount of insurance or change of coverage (1) as to the interests of Landlord by reason of any act or omission of Tenant, and (2) without the insurer's giving Landlord thirty (30) days' prior written notice of such action. Tenant shall deliver evidence of all required insurance and receipts evidencing payment of the premium for such insurance (and, upon request, copies of all required insurance policies, including endorsements and declarations) to Landlord on or before the Commencement Date and at least annually thereafter.

- C. *Indemnification of Landlord.* Tenant shall reimburse Landlord for, and shall indemnify, defend and hold Landlord, its employees and agents harmless from and against, all costs, damages, claims, liabilities, expenses (including attorney's fees), losses and court costs suffered by or claimed against Landlord, directly or indirectly, based on or arising out of, in whole or in part from (a) use and occupancy of the Demised Premises or the use(s), activity(ies) or any business conducted therein by Tenant, (b) any act or omission of Tenant or any invitee, (c) any breach of Tenant's obligations under this Lease, including failure to surrender the Demised Premises upon the expiration or earlier termination of the Lease term, or (d) any entry by Tenant or any invitee upon the Demised Premises prior to the Commencement Date.
- D. *Increase in the rate of insurance caused by Tenant.* Tenant shall not conduct any activity or place any item in or about the Demised Premises which may increase the rate of any insurance on the Demised Premises. If any increase in the rate of such insurance is due to any such activity or item, then (whether or not Landlord has consented to such activity or item) Tenant shall pay the amount of such increase. The statement of any insurance company or insurance rating organization (or other organization exercising similar functions in connection with the prevention of fires or the correction of hazardous conditions) that such an increase is due to any such activity or item shall be conclusive evidence thereof.
- E. *Waiver.* Tenant hereby releases Landlord, its property manager and their respective agents and employees from, and waives all claims for, damage or injury to person or property and loss of business sustained by Tenant and resulting from the Demised Premises or any part thereof, or any equipment therein, becoming in disrepair, or resulting from any accident in or about the Demised Premises. This paragraph shall apply particularly, but not exclusively, to: flooding, damage caused by equipment and apparatus, water, snow, frost, steam, excessive heat or cold, broken glass, sewage, gas, odors, excessive noise or vibration or the bursting or leaking of pipes, plumbing fixtures or sprinkler devices. Without limiting the generality of the foregoing, Tenant waives all claims and rights of recovery against Landlord, its property manager and their respective agents and employees for any loss or damage to any property of Tenant, which loss or damage is insured against, or required to be insured against, by Tenant pursuant to this Article, whether or not such loss or damage is due to the fault or negligence of Landlord, its property manager or their respective agents or employees, and regardless of the amount of insurance proceeds collected or collectible under any insurance policies in effect.
- F. *Financial Condition and Financial Covenants.* Tenant acknowledges that the financial capability of Tenant to perform its obligations hereunder is material to Landlord and that Landlord would not enter into this but for its belief, based on its review of Tenant's

financial statements, that Tenant is capable of performing such financial obligations, Tenant hereby represents, warrants and certifies to Landlord that its financial statements and all related documents and information previously furnished to Landlord were at the time given true and correct in all material respects and that there have been no material subsequent changes thereto as of the date of this Lease. At any time during the Term, within thirty (30) calendar days after Landlord's request therefor, Tenant shall furnish to Landlord Tenant's most recent audited financial statements (including any notes) or, if no such audited statements have been prepared, such other financial statements (and notes) as may have been prepared by an independent certified public accountant or, failing those, Tenant's internally prepared financial statements certified by Tenant's chief financial officer. Tenant shall discuss its financial statements with Landlord and shall give Landlord access to Tenant's books and records in order to enable Landlord to verify the financial statements.

ARTICLE XI. LOSS OR DAMAGE TO PROPERTY OR PERSONS

All personal property belonging to the Tenant, located on or about the Demised Premises shall be there at the sole risk of the Tenant; and neither the Landlord nor Landlord's agent shall be liable for the theft or misappropriation thereof nor for any damage or injury thereto, nor for damage or injury to the Tenant or any of its officers, agents or employees or to other persons or to any property caused by fire, explosion, water, gas, electricity, leaks from the roof or other portion of the Demised Premises, the bursting or leaking of pipes, plumbing, electrical wiring and equipment or fixtures of any kind, or by any act or neglect of other tenants or occupants of the Demised Premises, or due to any other cause whatsoever, unless resulting from the willful acts of the Landlord, its employees, agents or representatives. Tenant shall give immediate notice to Landlord in case of fire or accident in the Demised Premises or of any defects, damage or injury therein or in any fixtures or equipment.

ARTICLE XII. REPAIRS AND MAINTENANCE--TENANT

- A. *Tenant responsibility.* The Demised Premises, and all of the Landlord-owned furniture, fixtures and equipment located therein, (including, without limitation, lighting and electrical fixtures, appliances, plumbing fixtures, build-in cabinetry, and all interior plate glass panels, flat glass such as windows and doors, and area skylights, and alterations thereof) (collectively "Demised Premises and Fixtures") shall be kept and maintained by the Tenant in good working order and condition.
- B. *Grounds Maintenance.* Tenant shall reasonably maintain the grounds exterior to the Demised Premises including: onsite walkways, and adjacent public sidewalks; grass mowing; landscaping; ice/snow removal; and maintenance of exterior light fixtures.
- C. *Cleaning/Refuse Removal Services.* Tenant shall be responsible for cleaning the Demised Premises, either itself or using a janitorial service, so that the Demised Premises and Fixtures shall be neat and clean at all times. Tenant shall be responsible for removing refuse from the Demised Premises.
- D. *Surrender Obligation.* At the expiration or earlier termination or cancellation of this Lease, Tenant shall surrender all of the Demised Premises and Fixtures to Landlord in as good condition as at the time of delivery, subject to reasonable wear and tear.

- E. *Landlord rights.* If Tenant fails to perform any of its obligations under this Article, then Landlord may perform such obligations and Tenant will pay as additional Rent to Landlord the cost of such performance, including an amount sufficient to reimburse Landlord for overhead and supervision, within thirty (30) calendar days after receipt of Landlord's written demand therefor. For purposes of performing such obligations, or to inspect the Demised Premises, Landlord may enter the Demised Premises upon reasonable prior notice to Tenant (except in cases of actual or suspected emergency, in which case no prior notice will be required) without liability to Tenant for any loss or damage incurred as a result of such entry (except if directly due to or as a result of the gross negligence or willful misconduct of Landlord, provided, however, Landlord shall have no liability for any special or consequential damages suffered either by Tenant or any party claiming through Tenant); Landlord will take reasonable steps in connection with such entry to minimize any disruption to Tenant's business or its use of the Demised Premises. All injury to the Demised Premises and Fixtures, or any of them, caused by moving any property of the Tenant, its agents, employees, independent contractors, licensees, invitees, or visitors, as well as any other damage due to the neglect of the Demised Premises and Fixtures, or any of them, may be repaired by the Landlord at the expense of Tenant and such costs of repair shall become due and payable upon delivery of a statement of such costs by Landlord to Tenant.
- F. *Other repairs.* All other repairs, including repairs of structural elements, the exterior of the Demised Premises, and the Common Areas, if such repairs have not been necessitated by the act, fault, or negligence of Tenant, or Tenant's agents, shall be the sole responsibility of Landlord.

ARTICLE XIII. REPAIRS AND MAINTENANCE--LANDLORD

- A. *Maintenance of structural elements, etc.* The Landlord shall, at its expense, maintain the Structural Elements and Common Areas, as defined below, in good condition and shall repair the same with reasonable diligence when necessary.

"Structural elements" shall include the roof, exterior walls, structural supports, windows or window systems inherent to architectural profile of the building, and major systems such as fire alarm, plumbing, electrical, heating, air conditioning, and ventilation systems.

"Common areas" include the main lobby, elevator lobbies, elevators, stairways, toilets, hallways, sidewalks and entrances and parking areas, except those elevator lobbies, toilets and hallways that are actually located within the area of the Demised Premises, which shall be the responsibility of the Tenant.

- B. *Maintenance and Repair of Common Areas.* Landlord shall reasonably maintain the foundations, exterior walls, masonry, structural floors, and roof, the portions of the heating, ventilating and air conditioning systems serving the Common Areas of the Property (excluding those which serve only a particular tenant's Demised Premises), and elevators as such elements affect the Demised Premises; but in no event shall Landlord be obligated to repair or maintain glass, windows, skylights, or doors of the Demised Premises (whether interior or exterior), which shall be Tenant's responsibility, nor shall Landlord be obligated to repair or maintain any alterations installed by or on behalf of Tenant or to repair or

restore any damage to the Common Areas caused by any act or omission of Tenant or Tenant's employees, agents, contractors or invitees.

C. *Timing.* Repairs performed by the Landlord shall be at a time and in a manner so as not to unreasonably interfere with Tenant's normal business operations. Landlord's failure to use all reasonable diligence in making repairs which are Landlord's responsibility under this Lease, shall give Tenant the right to abate his rent by an amount proportionate to the inconvenience thereby caused Tenant.

D. *Requests for Maintenance and Repair.* Requests for maintenance and repair of the Demised Premises that are the responsibility of Landlord shall be submitted promptly in writing to:

PropertyManagement@Charlottesville.gov

or

<https://webnotifications.charlottesville.gov/>

E. *Property Inspection.* Landlord shall have the right to conduct property inspections at reasonable times such as prior to lease execution, lease renewal or annual lease anniversary date. Landlord will provide Tenant with ample notice and intent of inspection.

ARTICLE XIV. SERVICES AND UTILITIES

A. *Separately metered utilities.* Notwithstanding anything to the contrary contained herein, Landlord intends to utilize separate meters with respect to Tenant's use of water/sewer, gas, telephone and electric utility services. In such event, Tenant shall be responsible for the cost of its own metered utility usage only. In the event that one or more of such services cannot be separately metered, Tenant shall pay its Proportionate Share of the cost incurred by Landlord for such services, as additional rent, as set forth within Article V.

B. Tenant shall be solely responsible for all other utility or other services required by Tenant for or in connection with its use of the Demised Premises (such as internet service, trash removal, etc.).

C. *Heating, ventilation and air conditioning.* As part of the consideration of the basic rent herein provided to be paid by the Tenant, the Landlord agrees to continue to furnish and provide to the Tenant heating, ventilation and air conditioning in the Demised Premises, if applicable.

D. *Damages for breakdowns.* Landlord shall not be liable for damages to the Tenant for temporary failure to provide heat and/or air conditioning, or other services or amenities, if such failure results from the temporary breakdown of the plants or systems providing such services; provided, however, that in the event of such temporary failure, the Landlord shall promptly and at its own cost and expense repair the machinery or equipment so that said services will be restored.

E. *No Liability for Interruptions.* Tenant shall not be entitled to any abatement or reduction of Rent by reason of the unavailability of any of the services referred to in this Article when such failure results from casualty, force majeure, or any other cause beyond Landlord's immediate control, or for stoppages or interruptions of any such services when necessary

for Landlord to make repairs or improvements required by this Lease. Failure, stoppage or interruption of any such service shall not be construed as an actual or constructive eviction or as a partial eviction against Tenant, or release Tenant from the prompt and punctual performance by Tenant of the covenants contained herein.

ARTICLE XV. LANDLORD'S ADDITIONAL RESERVED RIGHTS

- A. Landlord reserves a right of entry for itself or its contractors, to enter into and upon the Demised Premises at reasonable times and upon reasonable notice given to Tenant, for the purpose of inspecting the Demised Premises, or for performing any action Landlord has a right or obligation to perform.
- B. Notwithstanding anything in this Lease to the contrary, all the perimeter walls of the Demised Premises except the interior surfaces thereof, any space in or adjacent to the Demised Premises used for shafts, stacks, ducts, pipes, conduits, wires and appurtenant fixtures, fan rooms, electrical lines, panels or other equipment used to transmit or store electricity, water lines, storm and sanitary sewer lines, all other utility lines, installations and meters, janitorial or other service areas, and all other facilities to which Tenant has not been granted rights hereunder (the "Reserved Areas and Facilities"), and the use thereof, are expressly excluded from the Demised Premises and reserved to Landlord. In addition, Landlord excepts and reserves the right from time to time, (a) to install, use, maintain, repair, replace and relocate within the Demised Premises any Reserved Areas and Facilities; and (b) to make alterations to the Demised Premises and to alter or relocate any entranceways, Common Areas or other Reserved Areas and Facilities (including without limitation all access driveways, walkways and parking areas, if any) serving the Demised Premises. Landlord further reserves the right, at any time, to lease, license, or otherwise permit the use by any person of such Reserved Areas and facilities.
- C. Landlord reserves the following additional rights: (a) to change the name or street address of the Property and/or the suite number of the Demised Premises; (b) to install, affix and maintain any and all signs on the exterior or interior of the Demised Premises; (c) to make repairs, decorations, alterations, improvements, replacements or modifications, whether structural or otherwise, in and about the Property, and for such any of the purposes identified in this Article, to enter upon the Demised Premises, temporarily close doors, corridors and other areas in the Demised Premises and interrupt or temporarily close services or use of Common Areas. Tenant shall be required to pay Landlord for overtime and similar expenses incurred by Landlord if such work is done other than during Landlord's ordinary business hours at Tenant's request; (d) to retain at all times, and to use in appropriate instances, keys to all doors within and into the Demised Premises; (e) to grant to any person or to reserve unto itself the exclusive right to conduct any business or render any service in the Demised Premises; (f) to show or inspect the Demised Premises at reasonable times and, if vacated or abandoned, to prepare the Demised Premises for re-occupancy; (g) to close any Common Areas to perform such acts as, in Landlord's reasonable judgment are necessary or desirable to maintain or improve the Property; (h) to install, use and maintain in and through the Demised Premises any pipes, conduits, wires and ducts serving the Property, provided that such installation, use and maintenance does not unreasonably interfere with Tenant's use of the Demised Premises; (9) to subdivide or re-subdivide the Property; and (i) to take any other action which Landlord deems reasonable in connection with the operation, maintenance or preservation of the Property.

- D. Landlord may exercise the rights set forth in this Article without notice and without liability to Tenant and the exercise of such rights shall not be deemed to constitute an eviction or disturbance of Tenant's use and possession of the Demised Premises and shall not give rise to any claim for set-off or abatement of rent or any other claim.

ARTICLE XVI. ALTERATIONS BY TENANT

- A. *Alterations Prohibited Without Landlord Consent.* Tenant shall not make any replacement, alteration, improvement or addition to or removal from (collectively an "alteration") the Demised Premises without the prior written consent of Landlord, which consent shall not be unreasonably withheld, provided any such proposed alternation will not (a) exceed the capacity of the systems or structure, (b) adversely affect the capacity, maintenance, operating costs or integrity of the structure or systems, (c) violate any agreement which affects the Demised Premises or binds Landlord, (d) alter the exterior of the Property in any way, or (e) violate or cause a breach of any mortgage or financing agreement affecting the Demised Premises or Property. Tenant shall not make any alteration to any other parts of the Demised Premises without Landlord's prior written consent, which consent may be withheld in Landlord's sole discretion.
- B. *Procedure; Review of Drawings and Specifications.* In the event Tenant proposes to make any alteration, Tenant shall, prior to commencing such alteration, submit to Landlord for prior written approval: (a) detailed drawings and specifications (copies of which drawings and any other project drawings shall be provided to Landlord and Landlord's agents in the form of a CAD disc upon completion of such alterations); (b) sworn statements, including the names, addresses and copies of contracts for all contractors; (c) all necessary permits evidencing compliance with all applicable Legal Requirements; (d) certificates of insurance inform and amounts required by Landlord, naming Landlord and any other parties designated by Landlord as additional insureds; and (e) all other documents and information as Landlord may reasonably request in connection with such alteration. Neither approval of the drawings and specifications nor supervision of the alteration by Landlord shall constitute a representation or warranty by Landlord as to the accuracy, adequacy, sufficiency or propriety of such drawings and specifications or the quality of workmanship or the compliance of such alteration with applicable Legal Requirements.
- C. *General Requirements.* Tenant shall pay the entire cost of the alteration and, if requested by Landlord, shall deposit with Landlord, prior to the commencement of the alteration, security for the payment and completion of the alteration in form and amount required by Landlord. Each alteration shall be performed in a good and workmanlike manner, in accordance with the drawings and specifications approved by Landlord and shall meet or exceed the standards for construction and quality of materials established by Landlord for the Demised Premises. In addition, each alteration shall be performed in compliance with all applicable legal requirements and all regulations and requirements of Landlord's and Tenant's insurers. Each alteration, whether temporary or permanent in character, unless otherwise specified, made by Tenant in or upon the Demised Premises (excepting only Tenant's furniture, removable equipment and removable trade fixtures) shall become Landlord's property and shall remain upon the Demised Premises at the expiration or termination of this Lease without compensation to Tenant. Notwithstanding the foregoing, Landlord shall have the right to require Tenant to remove any alteration at Tenant's sole cost and expense.

- D. *ADA Applicability.* Tenant acknowledges that the Demised Premises may constitute a place of public accommodation or a facility under Title III of the Americans with Disabilities Act (the “ADA”) and that the ADA is applicable to both an owner and a lessee of a place of public accommodation or facility. Tenant further acknowledges that under the ADA any structural alteration to the Demised Premises must comply with accessibility standards set forth in the rules promulgated by the Department of Justice at 28 C.F.R. 36.101 *et seq*, Notwithstanding anything in this Lease to the contrary, in the event Tenant makes any structural alteration to the Demised Premises which would require compliance with Title III of the ADA and the accessibility standards promulgated by the Department of Justice, Tenant agrees to design and such structural alterations so as to comply with the ADA and the accessibility standards.
- E. *Liens.* Upon completion of any alteration, Tenant shall promptly furnish Landlord with sworn contractor’s acknowledgements of payment in full and final waivers of lien in form and substance satisfactory to Landlord covering all labor and materials included in such alteration. Tenant shall not permit any mechanic’s lien to exist against the Property, or any part thereof, arising out of any alteration performed, or alleged to have been performed, or any service or work or material provided or furnished to Tenant or the Demised Premises by or on behalf of Tenant. If any such lien exists, Tenant shall, within ninety (90) days thereafter, have such lien discharged of record or deliver to Landlord a recordable bond in form, amount, and issued by a surety satisfactory to Landlord indemnifying Landlord against all costs and liabilities resulting from such lien and the foreclosure or attempted foreclosure thereof. If Tenant fails to have such liens so released or to deliver such bond to Landlord, Landlord, without investigating the validity of such lien, may pay or discharge the same and Tenant shall reimburse Landlord upon demand for the amount so paid by Landlord, including expenses and attorneys’ fees.
- F. *Heating, Ventilation and Cooling.* If Tenant installs any machines, equipment or devices in or about the Demised Premises that do not constitute customary office equipment, and if such machines, equipment or devices cause the temperature in any part of the Demised Premises to exceed (other than to a de minimis extent) the temperature the building’s mechanical system would be able to maintain in the Demised Premises were it not for such machines, equipment or devices, then Landlord reserves the right to install, upon prior notice to Tenant, supplementary air conditioning units in the Demised Premises or elsewhere in the building, and Tenant will pay to Landlord all reasonable costs of installing, operating and maintaining such supplementary units.

ARTICLE XVII. REPRESENTATIONS OF LANDLORD

Landlord hereby represents and warrants to Tenant that, as of the date of its execution of this Lease:

- A. *Defective Drywall.* Landlord is not aware of the existence of any defective drywall as defined by Va. Code Ann. § 36-156.1 on the Demised Premises.
- B. *Mold.* Landlord is not aware of the existence of any visible evidence of mold on the Demised Premises in areas readily accessible within the interior of the Demised Premises.
- C. *Authority.* Landlord has full legal authority and right to grant to Tenant the estate hereby demised and the easements and appurtenances thereunto pertaining.

- D. **Zoning.** The City's zoning administrator, in consultation with the City Attorney, has verified that the uses authorized within Article IV of this Lease are allowed by right at the Property under the City's zoning ordinance.

ARTICLE XVIII. REPRESENTATIONS OF TENANT

Tenant hereby represents and warrants to Landlord that, as of the date of its execution of this Lease:

- A. **Bankruptcy Actions.** There is no bankruptcy action, pending or threatened, against or affecting the Tenant;
- B. **Authorization to do business within Virginia.** Tenant represents and warrants to the Landlord that it is an entity lawfully organized and in good standing under the laws of the Commonwealth of Virginia, and, if Tenant is a corporation, limited liability company, or other entity required to register with the Virginia State Corporation Commission, Tenant represents and warrants that it is active and currently authorized to do business within Virginia.
- C. **Nonprofit status.** If Tenant is required by this Lease to pay only nominal rent for the Demised Premises, Tenant represents and warrants that it is a charitable organization, institution or corporation authorized to receive appropriations, gifts or donations of money or property, real or personal, from the Landlord, under the provisions of Virginia Code Sec. 15.2-953. Records which document Tenant's nonprofit status are attached as **Exhibit C** (if applicable).

ARTICLE XIX. COMPLIANCE WITH LAWS AND REGULATIONS

The Tenant shall, at its own expense, properly and promptly comply with and execute all laws, ordinances, rules, regulations and requirements, as the same now exist or as the same may hereafter be enacted, amended or promulgated by any federal, state or municipal authority, and/or any department or agency thereof, relating to the Tenant's use of the Demised Premises or of the operation of the Tenant's business therein.

ARTICLE XX. DEFAULT BY TENANT

- A. **Events of Default.** Tenant shall be deemed to be in default under this Lease, if:
- 1) The Tenant shall fail to pay any rent due hereunder, or any other costs and expenses for which the Tenant shall be responsible hereunder, within seven (7) days after notice from the Landlord specifying the item or items alleged to be due and unpaid, unless the Tenant shall in good faith dispute its liability therefor or the propriety of the amount claimed (other than rent);
 - 2) Tenant shall fail or neglect to keep and perform each and every one of the other covenants, conditions and agreements herein contained and on the part of the Tenant to be kept and performed, within thirty (30) days after written notice from the Landlord specifying the items alleged to be in default, unless (1) the curing of such default will take more than thirty (30) days, in which event Tenant shall be deemed to be in default only if it does not commence the curing of such default within the said thirty (30) day period and carry it, in good faith, to prompt completion; or (2) the Tenant shall, in good faith, dispute the existence of any default or the extent of its liability therefor, in which

- event the Tenant shall be deemed to be in default only if it fails, within thirty (30) days after the agreement or final adjudication, to commence the curing of such default as is adjudged to exist or which the Landlord and the Tenant shall agree exists, and to carry it, in good faith, to prompt completion;
- 3) If the Tenant shall make an assignment of its assets for the benefit of creditors, or if the Tenant shall file a voluntary petition in bankruptcy, or if an involuntary petition in bankruptcy or for receivership be instituted against the Tenant and the same be not dismissed within thirty (30) days of the filing therefor, or if the Tenant be adjudged bankrupt, then and in any of said events, unless otherwise prohibited by the United States Bankruptcy Code, this Lease shall immediately cease and terminate at the option of the Landlord with the same force and effect as though the date of said event was the day herein fixed for expiration of the term of this Lease;
 - 4) In the event the Tenant abandons the Demised Premises, either (i) by removing all of Tenant's personal property from the Demised Premises, or (ii) by Tenant's failure to occupy the Demised Premises for a period in excess of sixty (60) days, the Landlord may, at its option, accelerate the entire unpaid balance of the basic annual rent for unexpired portion of the Lease, and take action to collect same as the Landlord deems appropriate. The Landlord may re-enter the Demised Premises, and such re-entry shall not be deemed a surrender and termination of the Lease. It shall be deemed to be a retaking for the purpose of re-letting the Demised Premises and the Landlord may make such alterations, improvements, repairs, etc. as it deems necessary to prepare the Demised Premises for re-letting. Neither the Landlord's re-entry nor failure to re-enter shall be deemed a waiver of any claim it may have against the Tenant for the remaining portion of the Lease. The Tenant remains liable to the Landlord for the entire unpaid balance plus all damages that the Landlord may have suffered by reason of Tenant's abandonment, less credit given for any rental received by the Landlord from a successor tenant. If the successor tenant pays a rent that exceeds the rent obligation of the Tenant hereunder, the Landlord shall be under no obligation to the Tenant to account for or pay over such excess.
- B. If a default of any covenant, condition or agreement contained in this Lease shall exist, material or otherwise, Tenant's right to possession shall thereupon cease and Landlord shall be entitled to the possession of said Demised Premises and to re-enter the same without demand for rent or for possession. Landlord may proceed forthwith to recover possession of said Demised Premises by process of law, any notice to quit or of intention to exercise such option or to re-enter said Demised Premises being hereby **EXPRESSLY WAIVED BY TENANT**. Further, Landlord at its sole option may accelerate the unpaid rent for the unexpired portion of the Lease, giving credit for any proceeds from the re-letting in whole or in part of the Demised Premises and improvements by Landlord to others. Tenant will be liable to Landlord for all court costs and reasonable attorney's fees in the event Tenant shall become in default and Landlord incurs court costs and/or attorney's fees in obtaining possession of the Demised Premises or in the enforcement of any covenant, condition or agreement herein contained, whether through legal proceedings or otherwise, and whether or not any such legal proceedings be prosecuted to a final judgment.
- C. To establish reasonable attorney's fees, the Landlord may present a signed affidavit from legal counsel as to the fees claimed and the services rendered and anticipated to be rendered to collect the unpaid claim of Landlord. All objections to this method of proof are hereby

expressly waived by Tenant. The parties agree that future attorney's fees may be claimed hereunder.

D. *Remedies for Default.*

- 1) *Entry/Termination.* Upon the occurrence of a Default, Landlord may elect to terminate this Lease, or, without terminating this Lease, Landlord may terminate Tenant's right to possession of the Demised Premises—in either case, after giving written notice thereof to Tenant. Upon any such termination, Tenant shall immediately surrender and vacate the Demised Premises and deliver possession thereof to Landlord. Tenant grants to Landlord the right, without notice to Tenant, to enter and repossess the Demised Premises, to expel Tenant and any others who may be occupying the Demised Premises, and to remove any and all property therefrom, without being deemed in any manner guilty of trespass and without relinquishing Landlord's rights to any rent or any other right given to Landlord hereunder or by operation of law. In addition, Landlord may alter any locks and other security devices at the Demised Premises.
- 2) *Re-letting the premises.* If Landlord terminates Tenant's right to possession of the Demised Premises without terminating this Lease, Landlord may re-let the Demised Premises or any part thereof. In such case, Landlord shall use reasonable efforts to re-let the Demised Premises on such terms as Landlord shall reasonably deem appropriate; provided, however, Landlord may first lease Landlord's other available space and shall not be required to accept any tenant offered by Tenant or to observe any instructions given by Tenant about such re-letting. Tenant shall reimburse Landlord for the costs and expenses of re-letting the Demised Premises, including, but not limited to, all brokerage, advertising, legal, alteration and other expenses incurred to secure a new tenant for the Demised Premises.
- 3) *Damages.* If Landlord terminates this Lease pursuant to the terms and provisions of this Article Landlord may recover from Tenant, and Tenant shall pay to Landlord, on demand, all rent and other charges payable by Tenant to Landlord through the date of termination, and, in addition, shall pay to Landlord as damages, at the election of Landlord, amounts equal to the rent which would have been payable by Tenant had this not been so terminated, payable upon the due dates therefor specified herein following such termination and until the Expiration Date. A suit for the recovery of such damages, or any installments thereof, may be brought by Landlord from time to time at its election, and nothing contained herein shall be deemed to require Landlord to postpone suit until the date when the Term of this Lease would have expired if it had not been terminated hereunder.
- 4) *Landlord's Lien.* In addition to any statutory lien for rent in Landlord's favor, Landlord (the secured party for purposes hereof) shall have, and Tenant (the debtor for purposes hereof) hereby grants to Landlord an express contract and lien and a continuing security interest to secure the payment of all Rent and the performance of all other obligations due hereunder from Tenant, upon all goods, wares, equipment, fixtures, furniture, inventory, accounts, contract rights, chattel paper and other personal property of Tenant (and any transferees, subtenants or other occupants of the Demised Premises) presently or hereafter situated on the Demised Premises, and upon all proceeds of any insurance which may accrue to Tenant by reason of damage or destruction of any such property and all proceeds of any of the foregoing. In the Event of Default under this Lease, Landlord shall have, in addition to any other remedies provided herein or by law, all

- rights and remedies of a secured party under the Virginia Uniform Code, including without limitation, the right to sell the property described in this paragraph at public or private or sale or auction upon thirty (30) days' notice to Tenant, which notice Tenant hereby agrees is adequate and desirable in Landlord's discretion to perfect the security interest hereby conveyed. Any statutory lien for rent is not hereby waived, the express contractual lien herein granted being in addition and supplementary thereto. Landlord and Tenant agree that this Lease and the security interest granted herein serve as a financing statement, and a copy or photographic or other reproduction of this paragraph of this Lease may be filed of record by Landlord and have the same force and effect as the original.
- 5) *Landlord's Right to Cure.* Landlord may, but shall not be obligated, to perform any obligation of Tenant under this Lease, and if Landlord so elects, all costs and expenses paid by Landlord in performing such obligation, together with interest at the rate specified in Article VI, shall be reimbursed by Tenant to Landlord on demand.
- E. *Cumulative Remedies.* Any and all remedies set forth in this Lease: (a) shall be in addition to any and all other remedies Landlord may have at law and/or in equity, (b) shall be cumulative, and (c) may be pursued successively or concurrently as Landlord may elect. The exercise of any remedy by Landlord shall not be deemed an election of remedies or preclude Landlord from exercising any other remedies in the future.
- F. *No Waiver.* No receipt of money by Landlord from Tenant after termination of this Lease or after the service of any notice or after the commencing of any suit or after final judgment for possession of the Demised Premises shall renew, reinstate, continue or extend the Term or affect any such notice or suit. No waiver of any default of Tenant shall be implied from any omission by Landlord to take any action on account of such default if such default persists or be repeated, and no express waiver shall affect any default other than the default specified in the express waiver and then only for the time and to the extent therein stated.
- G. *No Accord and Satisfaction.* No payment by Tenant or receipt and acceptance by Landlord of a lesser amount than the Annual/ Monthly Base Rent and any Additional Rent shall be deemed to be other than part payment of the full amount then due and payable; nor shall any endorsement or statement on any check or any letter accompanying any check, payment of Rent or other payment, be deemed an accord and satisfaction; and Landlord may accept, but is not obligated to accept, such part payment without prejudice to Landlord's right to recover the balance due and payable or to pursue any other remedy provided in this Lease Agreement or by law.
- H. *Agreements Applicable to Tenant's Bankruptcy.* Notwithstanding anything to the contrary contained herein, and without prejudice to Landlord's right to require a written assumption from each assignee, any person or entity to whom this Lease is assigned including, without limitation, assignees pursuant to the provisions of the Bankruptcy Code, 11 U.S.C. Paragraph 101 *et seq.*, (the "Bankruptcy Code") shall automatically be deemed, by acceptance of such assignment or sublease or by taking actual or constructive possession of the Demised Premises, to have assumed all obligations of Tenant arising under this Lease Agreement, effective as of the earlier of the date of such assignment or sublease or the date on which the assignee or sublessee obtains possession of the Demised Premises. In the event this Lease is assigned to any person or entity pursuant to the provisions of the Bankruptcy Code, any and all monies or other consideration payable or otherwise to be delivered in connection with such assignment shall be paid or delivered to Landlord or

shall remain the exclusive property of Landlord and not constitute the property of Tenant or Tenant's estate within the meaning of the Bankruptcy Code. In the event of any Default described above, in order to provide Landlord with the assurances contemplated by the Bankruptcy Code, in connection with any assignment and assumption of this Lease, Tenant must fulfill the following obligations, in addition to any other reasonable obligations that Landlord may require, before any assumption of the Lease is effective: (a) all events of default must be cured within thirty (30) days after the date of assumption; (b) all actual monetary losses incurred by Landlord (including, but not limited to, reasonable attorneys' fees) must be paid to Landlord within thirty (30) days after the date of assumption; and (c) Landlord must receive within thirty (30) days after the date of assumption a security deposit in the form of a letter of credit in an amount equal to three (3) months of Base Monthly Rent (using the Base Rent in effect for the first full month immediately following the assumption) and an advance prepayment of Base Monthly Rent in the amount of three (3) months Base Monthly Rent (using the Base Rent in effect for the first full month immediately following the assumption), both sums to be held by Landlord in accordance with this and deemed to be rent under this Lease for the purposes of the Bankruptcy Code, as amended and from time to time in effect. In the event this is assumed in accordance with the requirements of the Bankruptcy Code and this Lease, and is subsequently assigned, then, in addition to any other reasonable obligations that Landlord may require and in order to provide Landlord with the assurances contemplated by the Bankruptcy Code, Landlord shall be provided with (a) a financial statement of the proposed assignee prepared in accordance with generally accepted accounting principles consistently applied, on a cash basis, which reveals a net worth in an amount sufficient, in Landlord's reasonable judgment, to assure the future performance by the proposed assignee of Tenant's obligations under this Lease; or (b) a written guaranty by one or more guarantors with financial ability sufficient to be in form and content satisfactory to Landlord and to cover the performance of all of Tenant's obligations under this Lease.

ARTICLE XXI. DEFAULT BY LANDLORD

- A. Landlord shall be deemed to be in default under this Lease, if it shall fail to provide the Demised Premises in the condition agreed to herein, free from any interference with Tenant's use and enjoyment thereof, or to provide all services within the standards agreed upon.
- B. In case of Landlord's default, Tenant shall have the following remedies:
 - 1) Tenant shall have the option of terminating this Lease for any material default by Landlord. Such default shall include, but not be limited to, denying Tenant access to the Demised Premises for any reason other than Tenant's prior default, or failure to perform with all reasonable speed and efficiency any repair which is the obligation of the Landlord under this Lease; and
 - 2) If any default by Landlord is due to its failure to make necessary repairs with reasonable dispatch after notice from Tenant that such repairs are needed, Tenant may cause the repairs to be made at its own expense. The reasonable expense of such repairs may then be deducted by Tenant from its next due installment of Base Monthly Rent; and
 - 3) Tenant shall have the right to abate its rent proportionately when Landlord, for any cause reasonably within its control, is unable or unwilling to provide the Demised

Premises in the condition agreed, free from interference or obstruction, or the services within the standards or the hours agreed.

ARTICLE XXII. SURRENDER OF DEMISED PREMISES

Upon the expiration or other termination of this Lease, Tenant shall quit and surrender the Demised Premises to Landlord in good order, repair and condition, ordinary wear and tear, acts of God, fire, and other casualty (not resulting from Tenant's or Tenant's agents', employees' or invitees' acts or omissions) excepted. Tenant shall on the day of expiration or termination of this Lease, or prior to such date, remove all property of Tenant, and Tenant shall within two weeks after expiration or termination repair all damage to the Demised Premises caused by such removal and make reasonable restoration of the Demised Premises to the condition in which they existed prior to the installation of the property so removed.

ARTICLE XXIII. SIGNAGE

Tenant shall have no right to erect or install new canopies, marquees, or advertising devices, including signs, on the exterior of the Demised Premises, and Tenant shall have no right to erect or install any new sign within the interior of the Demised Premises that are visible from the exterior of the Demised premises, except with Landlord's prior written approval, which approval shall not be unreasonably withheld or delayed. All signs authorized by the Landlord must comply with applicable requirements of the City's zoning ordinance and the Uniform Statewide Building Code.

ARTICLE XXIV. ASSIGNMENT AND SUBLETS

- A. **Sublets.** Except as expressly stated in Article IV, Paragraph B, Tenant shall not assign or sublet the Demised Premises or any part thereof, without the prior written consent of Landlord.
- B. **Notice of request for assignment.** If Tenant wants to assign, sublet or otherwise transfer all or part of the Demised Premises, the Tenant shall give Landlord written notice ("Tenant's Request Notice") of the identity of the proposed assignee or subtenant and its business, all terms of the proposed assignment or subletting, the commencement date of the proposed assignment or subletting (the "Proposed Sublease Commencement Date") and the area proposed to be assigned or sublet (the "Proposed Sublease Space"). Tenant shall also transmit therewith the most recent financial statement or other evidence of financial responsibility of such assignee or subtenant and a certification executed by Tenant and the proposed assignee or subtenant stating whether any premium or other consideration is being paid for the proposed assignment or sublease. Tenant shall pay the expenses (including all attorney's fees) reasonably incurred by Landlord in connection with Tenant's request for Landlord to give its consent to any assignment, subletting, occupancy or mortgage.
 - 1) **Landlord's right to terminate.** Landlord shall have the right in its sole and absolute discretion to terminate this Lease with respect to the Proposed Sublease Space, by sending Tenant written notice within forty-five (45) days after Landlord's receipt of Tenant's Request Notice.
 - 2) If the Proposed Sublease Space does not constitute the entire Demised Premises and Landlord elects to terminate this Lease with respect to the Proposed Sublease Space,

- then: (a) Tenant shall tender the Proposed Sublease Space to Landlord on the Proposed Sublease Commencement Date as if the Proposed Sublease Commencement Date had been originally set forth in this Lease Agreement as the expiration date of the Lease term with respect to the Proposed Sublease Space, and (b) as to all portions of the Demised Premises other than the Proposed Sublease Space, this Lease shall remain in full force and effect except that the rent and other payments due hereunder shall be reduced proportionately. Tenant shall pay all expenses of construction required to permit the operation of the Proposed Sublease Space separate from the balance of the Demised Premises.
- 3) If the Proposed Sublease Space constitutes the entire Demised Premises and the Landlord elects to terminate this Lease, then (1) Tenant shall tender the Demised Premises to Landlord on the Proposed Sublease Commencement Date, and (2) the term shall terminate on the Proposed Sublease Commencement Date.
 - 4) **Excess rent or other charges paid by subtenant.** If any sublease, assignment or transfer (whether by operation of law or otherwise) provides that the subtenant, assignee or other transferee is to pay any amount in excess of the rent and other charges due under this Lease, then whether such excess be in the form of an increased rental, lump-sum payment, payment for the sale or lease of fixtures or other Leasehold improvements, or any other form (and if the applicable space does not constitute the entire Demised Premises, the existence of such excess shall be determined on a pro-rata basis), Tenant shall pay to Landlord any such excess upon such terms as shall be specified by Landlord and in no event later than ten (10) days after Tenant's receipt thereof. Landlord shall have the right to inspect Tenant's books and records relating to any sublease, assignment or other transfer. Any sublease, assignment or other transfer shall be effected on forms supplied or approved by Landlord.
- C. In the event that Landlord consents to an assignment, or to a sublease, and the Landlord collects or accepts rent from any assignee, subtenant or occupant, such conduct by Landlord shall not be construed as relieving the Tenant or any assignee, subtenant or occupant from the obligation of obtaining Landlord's written consent to any subsequent assignment, subletting or occupancy, and Tenant hereby assigns to Landlord any sum due from any assignee, subtenant or occupant of Tenant as security for Tenant's performance of its obligations pursuant to this Lease. Tenant authorizes each such assignee, subtenant or occupant to pay such sum directly to Landlord if such assignee, subtenant or occupant receives written notice from Landlord specifying that such rent shall be paid directly to Landlord. Landlord's collection of such rent shall not be construed as acceptance of such assignee, subtenant or occupant as tenant. All restrictions and obligations imposed pursuant to this Lease on Tenant shall be deemed to extend to any subtenant, assignee or occupant of Tenant, and Tenant shall cause such persons to comply with all such restrictions and obligations.
- D. **Assignment pursuant to provisions of Bankruptcy Code.** If this Lease is assigned to any person or entity pursuant to the provisions of the Bankruptcy Code, 11 U.S.C. § 101 *et seq.* (the "Bankruptcy Code"), any and all monies or other considerations payable or otherwise to be delivered in connection with such assignment shall be paid or delivered to the Landlord, shall be and remain the exclusive property of the Landlord, and shall not constitute the property of the Tenant or of the estate of Tenant within the meaning of the Bankruptcy Code. Any and all monies or other considerations constituting Landlord's

property under the preceding sentence not paid or delivered to Landlord shall be held in trust for the benefit of the Landlord and shall be promptly paid and/or delivered to the Landlord.

- E. **Mortgage of Demised Premises prohibited.** Tenant shall not mortgage or encumber the Demised Premises without Landlord's written consent, which consent may be granted or withheld in Landlord's sole and absolute discretion.
- F. **Dissolution, etc. of partnership, limited liability company or corporation deemed assignment.** If Tenant is a partnership, then any dissolution of Tenant or a withdrawal or change, whether voluntary, involuntary or by operation of law, or partners owning a controlling interest in Tenant shall be deemed a voluntary assignment of this Lease. If Tenant is a corporation or limited liability company, then any dissolution, merger, consolidation or other reorganization of Tenant, or any sale or transfer of a controlling interest in its capital stock, shall be deemed a voluntary assignment of this Lease.
- G. *Tenant to Remain Liable.* In no event shall any Transfer (whether or not approved by Landlord or permitted hereunder) release or relieve Tenant from its obligations to fully observe or perform all of the terms, covenants and conditions of this Lease on its part to be observed or performed (including liability arising during any renewal term of this Lease or with respect to any expansion space included in the Demised Premises). It is agreed that the liabilities and obligations of Tenant hereunder are enforceable either before, simultaneously with or after proceeding against any assignee, sublessee, licensee, sublicensee or other transferee of Tenant.
- H. *Attorneys' Fees.* Tenant shall pay Landlord, on demand as additional rent, any attorney's fees and expenses incurred by Landlord in connection with any proposed Transfer, whether or not Landlord consents to such Transfer.

ARTICLE XXV. HAZARDOUS MATERIAL

- A. For purposes of this Lease "Hazardous Material" means any flammable items, explosives, radioactive material, oil, toxic substance, material or waste or related materials, including any material or substance included in the definition of "hazardous wastes," "hazardous materials" or "toxic substances", now or hereafter regulated under any Legal Requirements, including, without limitation, petroleum-based products, paints, solvents, lead, cyanide, DDT, printing inks, acids, pesticides, ammonia compounds and other chemical products, asbestos, medical waste, polychlorinated biphenyls, and similar compounds. "Hazardous Material" shall also include, without limitation, any materials or substances which could trigger any employee "right to know" requirements or for which any regulatory or other governmental body has adopted any requirements for the preparation or distribution of a material safety data sheet.
- B. Tenant shall not cause or permit any Hazardous Material to be brought upon, produced, stored, generated, used, discharged or disposed of, in, on, under or about the Demised Premises, without the prior written consent of Landlord and then only in compliance with all applicable environmental legal requirements.
- C. Tenant shall execute such affidavits, representations and certifications from time to time as may be requested by Landlord, concerning Tenant's best knowledge and belief regarding the presence or absence of Hazardous Material in, on, under or about the Demised Premises and/or the Property.

D. Tenant shall defend, indemnify and hold harmless Landlord from and against any and all claims (including, without limitation, costs and attorneys' fees) arising from any breach of this Article. The indemnity, defense and hold harmless obligations in this Article shall be in addition to all other indemnity, defense and hold harmless obligations contained in this Lease.

ARTICLE XXVI. NOTICES

- A. Any notice required or permitted by this Lease to be given by either party to the other may be hand-delivered or sent by U.S. Mail, return receipt requested, with the sender retaining sufficient proof of having given such notice. No notice required or permitted by this Lease shall be effective if given only by electronic mail.
- B. All notices required by this Lease, unless otherwise designated in writing, shall be given to:

Tenant Mailing Address:
 Albemarle Charlottesville Historical Society
 200 Second Street, NE
 Charlottesville, VA 22902

 Delivery Address:
 Albemarle Charlottesville Historical Society
 200 Second Street, NE
 Charlottesville, VA 22902

Landlord Mailing Address:
 Office of the City Manager
 City of Charlottesville
 P.O. Box 911
 Charlottesville, VA 22902
 Attn: City Lease

 Delivery Address:
 Office of the City Manager
 City of Charlottesville
 605 E. Main Street, 2nd Floor
 Charlottesville, VA 22902
 Attn: City Lease

ARTICLE XXVII. QUIET ENJOYMENT

Upon payment by Tenant of all rent and other sums provided to be paid in this Lease, and the observance and performance of all the covenants, terms and conditions on Tenant's part to be observed and performed, Tenant shall have the peaceful and quiet use of the Demised Premises, and all rights, servitudes, and privileges belonging to, or in any way appertaining thereto, or

granted hereby for the terms stated, without hindrance, or interruption by Landlord or any other person or persons lawfully claiming by, through or under Landlord; subject, nevertheless, to the terms and conditions of this Lease.

ARTICLE XXVIII. NO IMPLIED WAIVERS

A waiver of any covenant or condition of this Lease shall extend to the particular instance only and in the manner specified and shall not be construed as applying to or in any manner waiving any further or other covenants, conditions or rights hereunder.

ARTICLE XXIX. ESTOPPEL CERTIFICATES

Tenant agrees, at any time and from time to time, upon not less than five (5) days' prior written notice by Landlord, to execute, acknowledge and deliver to Landlord a statement in writing (a) certifying that this Lease is in full force and effect (or if there have been modifications, that the Lease is in full force and effect as modified and stating the modifications), (b) stating the dates to which the rent and other charges hereunder have been paid by Tenant, (c) stating whether or not to the best knowledge of Tenant, Landlord is in default in the performance of any covenant, agreement or condition contained in this Lease, and, if so, specifying each such default of which the Tenant may have knowledge, and (d) stating the address to which notices to Tenant should be sent. Any such statement delivered pursuant hereto may be relied upon by any owner, prospective purchaser, or financier of the Tenant's business.

ARTICLE XXX. NO PARTNERSHIP CREATED

Nothing contained in this Lease shall be deemed or construed to create a partnership or joint venture of, or between, Landlord and Tenant, or to create any other relationship between the parties hereto other than that of Landlord and Tenant.

ARTICLE XXXI. TENANT'S ORGANIZATION, AUTHORITY AND NET WORTH

In the event Tenant is a corporation (including any form of professional association), partnership (general or limited), or other form of organization other than an individual (each entity is individually referred to herein as "Organizational Entity"), then Tenant hereby covenants, warrants and represents: (1) that the individual executing this Lease is duly authorized to execute and/or attest and deliver this Lease on behalf of Tenant in accordance with the organizational documents of Tenant, (2) that this Lease is binding upon Tenant, (3) that Tenant is duly organized and legally existing in the state of its organization, and is qualified to do business in the Commonwealth of Virginia, and (4) that the execution and delivery of this Lease by Tenant will not result in any breach of, or constitute a default under any mortgage, deed of trust, lease, loan, credit agreement, partnership agreement or other contract or instrument to which Tenant is a party or by which Tenant may be bound. If Tenant is an Organizational Entity, upon request, Tenant will, prior to the Commencement Date, deliver to Landlord true and correct copies of such organizational documents of Tenant as may be requested by Landlord in order to verify Tenant's organizational structure and authority to execute this Lease, including, without limitation, copies of an appropriate

resolution or consent of Tenant's board of directors or other appropriate governing body of Tenant authorizing or ratifying the execution and delivery of this Lease, which resolution or consent will be duly certified to Landlord's satisfaction by an appropriate individual with authority to certify such documents, such as the secretary or assistant secretary or the managing general partner of Tenant.

ARTICLE XXXII. BROKERS

Tenant represents and warrants that Tenant has not dealt with any broker(s) in connection with this Lease and that, to the best of the Tenant's knowledge, no broker negotiated this Lease or is entitled to any commission in connection herewith. Tenant agrees to indemnify, defend and hold harmless from and against any claims for a fee or commission made by any broker claiming to have acted by or on behalf of Tenant in connection with this Lease.

ARTICLE XXXIII. TENDER OF LEASE NOT AN OFFER TO LEASE; EXECUTION AND DELIVERY

Submission of this instrument for examination or signature by Tenant does not constitute a reservation of space or an option for space, and it is not effective until execution and delivery by both Landlord and Tenant. Execution and delivery of this Lease by Tenant to Landlord, with Tenant's signature, shall constitute an irrevocable offer by Tenant to lease the Demised Premises on the terms and conditions set forth herein, which offer may not be revoked for thirty (30) days after such delivery.

ARTICLE XXXIV. NO IMPLIED SURRENDER

Neither the delivery of keys to any employee of Landlord or to Landlord's agent or any employee thereof, nor the termination or expiration of any sublease or assignment for all or any portion of the Demised Premises, nor the abandonment of the Demised Premises by Tenant, shall operate as any termination of this Lease or an acceptance of surrender of the Demised Premises by Landlord, absent the explicit written agreement of the Landlord to same.

ARTICLE XXXV. LIMITATION OF LANDLORD'S LIABILITY

Landlord shall have the right in its sole and unrestrained discretion, to transfer and assign, in whole or in part, all of its rights and obligations in and to this Lease and/or the Lease or Property. The word "Landlord" is used in this Lease to include the Landlord named above as well as its successors and assigns, each of whom shall have the same rights, remedies, powers, authorities and privileges as it would have had if originally signed this as Landlord. Any such person, whether or not named herein, shall have no liability hereunder after it ceases to hold title to the Demised Premises, except for obligations which may have theretofore accrued. Neither Landlord nor any principal, member, officer, employee or partner of Landlord nor any owner of the Property, whether disclosed or nondisclosed, shall have any personal liability with respect to any of the provisions of this Lease, and neither Landlord, nor any parent or affiliate company, nor any principal, employee, officer, member or partner of Landlord shall have any personal liability to

Tenant for any liability of or claim against Landlord under this Lease beyond the equity of the Landlord in the Demised Premises and the Land.

ARTICLE XXXVI. ENTIRE AGREEMENT; MODIFICATION

- A. This Lease, together with exhibits attached hereto, represents the entire understanding between the parties, and there are no collateral or oral agreements or understandings between the parties as to any subject(s) herein contained.
- B. This Lease shall not be modified unless in writing of equal dignity signed by both parties.

ARTICLE XXXVII. PARTIAL INVALIDITY

If any provision of this Lease or the application thereof to any person or circumstance shall to any extent be held void, unenforceable or invalid, then the remainder of this Lease or the application of such provision to persons or circumstances other than those as to which it is held void, unenforceable or invalid shall not be affected thereby, and each provision of this Lease shall be valid and enforced to the fullest extent permitted by law.

ARTICLE XXXVIII. BINDING EFFECT

It is agreed that all of the terms and conditions of this Lease are binding upon the parties hereto, their administrators, heirs, successors and assigns, unless otherwise specified herein. All terms and conditions herein are also covenants.

ARTICLE XXXIX. APPLICABLE LAW

This Lease shall be governed in all aspects by the laws of the Commonwealth of Virginia, notwithstanding its conflict of laws provisions.

IN WITNESS WHEREOF, the parties have caused this Lease to be executed by their duly authorized representatives, following below:

[insert signature pages following]

CITY OF CHARLOTTESVILLE, VIRGINIA

By: _____

Date: _____

Title: _____

TENANT: ALBEMARLE COUNTY HISTORICAL SOCIETY d/b/a ALBEMARLE
CHARLOTTESVILLE HISTORICAL SOCIETY

By: _____

Date: _____

Print Name: _____

Title: _____

Exhibit A

Demised Premises



Exhibit B

Facilities Definitions and Terms of Use

Facilities Definitions:

Building Grounds and Parking Lot: Building Grounds and Parking Lot is defined as facility use or related systems found outside the 20-foot building perimeter boundary. Systems to include parking lots and lighting, playgrounds and lighting, swimming pools and lighting, Trail or walkways and lighting, athletic fields and lighting, and grounds requiring irrigation and lawn services. All directional signage, trash or recycling containers, benches and comfort stations are included in this section.

Component Renewal: Preventive maintenance activities that recur on a periodic and scheduled cycle of greater than 10 years.

Corrective Maintenance: Unscheduled maintenance repairs to correct deficiencies during the year in which they occur.

Custodial Services: Defined as services required to maintain interior and exterior building components in a sanitary and presentable condition. Services to include restroom cleaning and sanitizing, office waste removal and cleaning, common area cleaning and sanitizing, window cleaning, floor cleaning and trash pick-up and discarding. LOS would be contingent on building profile, occupancy levels, and cleaning standards as set forth by industry standards and guidelines.

Deferred Maintenance (DM): Maintenance that was not performed when it should have been or when it was scheduled and which, therefore, was put off or delayed for a future period. This DOES NOT include constructed asset deficiencies where there is non-compliance to codes (e.g. life safety, ADA, OSHA, environmental, etc.) and other regulatory or Executive Order compliance requirements. It does include engineering and/or contracted A&E services that support planning, design, and execution of deferred maintenance activities.

Demolition: Dismantling and removal, or surplus of a deteriorated or otherwise unneeded asset or item of IBE, includes necessary clean-up work, during the year in which the need occurred.

Emergency Maintenance: Maintenance activities that are unscheduled repair, to include call outs, to correct an emergency need to prevent injury, loss of property, or return asset to service. These repairs are initiated within a very short time period from which the need is identified, usually within hours.

Exterior Building Envelope: The Exterior envelope is defined as the structural components of the building, including roof and supporting architecture, roof drainage systems, load bearing walls, foundation, plumbing and sewer systems, electrical distribution network, HVAC systems including duct network and system controls, all affixed exterior lighting and controls. Exterior envelope can include up to a 20-foot perimeter from exterior walls that may contain walkways or building approaches, trash or recycling containers, walkway pole lighting, and perimeter foliage and irrigation.

Facility Event Make Ready and Breakdown Services: Defined as services required to set up or breakdown material to host events. Can include tables, chairs, lighting, custodial items and HVAC modulations. After event cleaning services are stand alone services that are not part of normally scheduled custodial services or provisions.

FF&E or FFE: Furniture, Fixtures and Equipment. Defined as movable furniture, fixtures, or other equipment that have no permanent connection to the structure of the building and can be owner or tenant furnished.

HVAC: Heating Ventilation and Air-Conditioning. Defined as any number of integrated or dedicated systems designed, and employed, to manage various air environmental conditions in a defined space or area.

Interior Building Envelope, Conditioned Spaces: The interior envelope for conditioned spaces includes all building fixtures, furnishings, or equipment (FF&E) integrated, but without dependency on the structural makeup or components of the building model. Interior envelope can include floors, ceiling panels and gridwork, wallboard and finishes, non-architectural equipment such as appliances, sound systems, door hardware, alarm systems, IT Systems and lighting. The Interior envelope for conditioned spaces will always have HVAC systems servicing the space but may also include passive solar or natural lighting systems.

Interior Building Envelope, Unconditioned Spaces: The Interior envelope for unconditioned spaces can include all elements as found in the Interior envelope for conditioned spaces but without artificial HVAC systems. Spaces can include warehouses, storerooms, pool pump and mechanical rooms and stand-alone sheds. Space can include passive solar systems or re-directional natural lighting design.

Level of Service (LOS): Level of Service as recommended by manufacturer, Best Practices as demonstrated through industry standards, or recommendations presented by prevailing Building or Equipment management. Level of Service can vary between facility due to equipment or building profile, environmental conditions, or previous maintenance activity.

Maintenance: Maintenance to repair unscheduled and scheduled deficiencies during the time period in which they occur. This includes preventive maintenance for buildings, structures, and installed building equipment (IBE) as recommended by the manufacturer. It also includes engineering and/or contracted Architectural and Engineering (A&E) services that support planning, design, and execution of maintenance activities.

Mobile Equipment Maintenance: All corrective, preventive, emergency, replacement, etc., maintenance done on mobile equipment assets, those assets directly contributing to the Real Property / Facility Maintenance mission.

OSHA: Occupational Safety and Health Administration. Responsible for setting and enforcing workplace safety and health standards in the United States. The agency was created in 1970 by the Occupational Safety and Health Act (OSH Act) and is a division of the U.S. Department of Labor.

NFPA: National Fire Protection Agency. A global self-funded nonprofit organization, established in 1896, devoted to eliminating death, injury, property and economic loss due to fire, electrical and related hazards.

Preventive Maintenance: Scheduled servicing, repairs, inspections, adjustments, and replacement of parts that result in fewer breakdowns and fewer premature replacements and achieve the expected life of constructed assets and IBE. These activities are conducted with a frequency of 1 year or less.

Recurring Maintenance: Preventive maintenance activities that recur on a periodic and scheduled cycle of greater than 1 year, but less than 10 years.

Shared Spaces: Mechanical, closets, or other shared space utilized concurrently by 2 or more contract participants on an ongoing or consistent manner.

Weather Related Services:

- Snow removal services
 - Building perimeter: pedestrian
 - Building vehicular traffic including loading docks
- High Wind
- Rain Events

Definitions Pertaining to Facility Use Conditions:

Assignable Area:

- Definition: The sum of all areas on all floors of a building assigned to, or available for assignment to, an occupant or specific use.
- Description: Included should be space subdivisions, as applicable, of the ten major room use categories for assignable space – classrooms, labs, offices, study facilities, special use, general use, support, health care, residential and unclassified – that are used to accomplish the organization’s mission.

Building Service Area:

- Definition: The sum of all areas on all floors of a building used for custodial supplies, sink room, housekeeping closets, and for occupant rest rooms.
- Description: Included should be housekeeping closets or similarly small cleanup spaces, maintenance material storage areas, trash collection points exclusively devoted to the storage of nonhazardous waste created by the building occupants. Loading docks for the explicit use for material pick up or delivery.

Circulation Area:

- Definition: The sum of all areas on all floors of a building required for physical access to some subdivision of space, whether physically bounded by partitions or not.
- Description: Included should be, but is not limited to, public corridors, fire towers, elevator lobbies, tunnels, bridges, and each floor’s footprint of elevator shafts, escalators and stairways. Areas deemed ingress / egress as defined by the Fire Marshall’s Office.

Electrical Panel / Fire Alarm Control Panel:

- Definition: The sum of all areas on all floors of a building designed to house electrical sub-panels, fire protection controls, and security controls integrated into the building operations.
- Description: Including electrical distribution sub-panels, Fire Alarm Panels and Security or Access Control Panels.

Mechanical Area:

- Definition: The sum of all areas on all floors of a building designed to house mechanical equipment, utility services, and shaft areas.
- Description: Included should be mechanical areas such as HVAC equipment, electrical switch gear and transformers, domestic hot water heaters or boilers.

Non-Assignable Area:

- Definition: The sum of all areas on all floors of a building not available for assignment to an occupant or for specific use, but necessary for the general operation of a building.
- Description: Included should be space subdivisions – building service, circulation and mechanical.

Facilities Terms of Use:

All Conditions set forth in this ‘Terms of Use’ are understood by the Tenant to be part of the Lease Agreement as executed between the City of Charlottesville and Tenant and are instituted to supplement agreed to limitations on facility use as set forth in the executed lease agreement.

Terms of Use:

- General Conditions:
 - No food products are to remain in an open and unsealed condition at end of business, where promotion of insect or other pest infestations could occur.
 - Gates or other facility modifications for the purpose of securing areas, are not authorized without explicit authorization from the City of Charlottesville Facilities Maintenance and only after review and approvals from the Fire Marshalls Office.
 - Building Fire and Evacuation Drills to be administered in accordance to City Fire Marshall requirements; including but not limited to, conformance of all Fire Marshall Regulations for ingress / egress routes.
 - Tenant shall have 48 hours to correct any space deficiencies unless otherwise approved by City Facilities Maintenance.
- Custodial Services:
 - Tenant to submit in writing upon request, a cleaning service schedule sufficiently detailed to address facility occupancy in all Assignable Areas.
 - Janitorial and sanitizing cleaning agents must only be used and in the manner specified by the product manufacturer.
 - Cleaning agents used for the purpose of cleaning and sanitizing Assignable Areas, must be pre-approved by City Facilities Maintenance Custodial Services.
 - All cleaning chemicals must be stored in accordance to standards through OSHA, NFPA and Industry Best Practices and limited to storing in Building Service Areas.
- Chemical Management:
 - An inventory of all stored chemicals used by tenant must be made available to City Facilities.
 - City Facilities Maintenance reserves the right to deny storage of any chemical or otherwise volatile material that presents a clear hazard to building and / or occupants.
 - A Safety Date Sheet (SDS) for each stored chemical must be displayed in a visible and easily assessable station near stored chemicals.
 - Chemical agents must not be stored on any wood, or otherwise absorbent material and must be stored on City Facilities Maintenance approved shelving systems in a manner consistent with OSHA, NFPA and Industry standards and best practices.
 - Dry goods or other cardboard boxed items to be stored in a manner consistent with industry best practices and in accordance with City Fire Marshall requirements.

- Floor surface to remain clean and clear of any material that presents hazards or rite of passage concerns in all Assignable, Circulation and Building Service Areas.
- Lighting:
 - All lighting fixtures must contain a full contingent of light products as specified by the light fixture. No failed or diminished light bulbs in lighting fixtures.
 - Light fixture diffusers must be periodically cleaned to promote a safe and healthy environment.
- Boiler and Mechanical Rooms:
 - Tenant shall not use and under any circumstance, any space in areas containing Boiler, Mechanical, or main electrical switch gear. Mechanical Areas to be accessible by City Facilities Maintenance staff only unless otherwise authorized by City Facilities Maintenance.
- Electrical Panel / Fire Alarm Control Panel (FACP)
 - Electrical Panel and FACP closets are not authorized to be used for storage by the tenant as found in Mechanical Areas.
 - Electrical Sub-Panel closets may be conditionally used and only under authorization from City Facilities Maintenance.
- Circulation Areas:
 - Under no conditions will stairways and stairway landings be used for storage or as an interim space for inventory replenishment.
 - No non-emergency or non-directional signage or communication notices are authorized to be placed on walls or on any free standing easels on stairway landings.
 - All circulation areas are to be free of obstructions and kept clean in accordance to Industry Best Practices.
 - Conformance to all Fire Marshall Regulations regarding Ingress / Egress routes.
- Heating, Ventilation and Air Conditioning (HVAC)
 - Systems common, or shared with other Tenants are considered “Common Infrastructure” and are the responsibility of the City to maintain.
 - Systems servicing Tenant spaces only, are considered “Dedicated Systems” and are typically smaller units such as residential or window units.
 - The Tenant is responsible for changing the Air Filter on a quarterly basis if determined by City Facilities Maintenance procedures. A written filter changing log is to be maintained and provided to the City upon request.
 - Repair and Maintenance of the system will be the responsibility of the City.
 - The Tenant is responsible for submitting a work request to the City in order to address any equipment concerns.
 - HVAC system operation will integrate energy and water management principles to optimize building performance and meet operational needs while supporting comfort and health. In support of this, the following provisions shall be implemented:
 - Mandatory Provisions:
 - During occupied hours, all thermostatically controlled heating/air conditioning units in City-owned/maintained facilities will be cooled or heated to a pre-determined temperature range:

Heating Season:	68 – 72 degrees F
Cooling Season:	72 – 76 degrees F

Exhibit C

Tenant's Non-Profit Status

Department of the Treasury

Internal Revenue Service
Washington, DC 20224

Date: DEC - 3 1970 In reply refer to:
Dec. 3, 1970 T:MS:EO:R:3-SP



Albemarle County Historical
Society, Inc.
c/o Bernard P. Chamberlain,
Resident Agent
219 Court Square
Charlottesville, Virginia 22901

Gentlemen:

We have considered your application for exemption from Federal income tax as an organization described in section 501(c)(3) of the Internal Revenue Code.

The information submitted shows you were incorporated on August 12, 1969, for the purpose of studying and preserving the history of Albemarle County, Virginia.

Your activities consist of collecting and preserving manuscript and printed materials and other physical remains pertaining to the history of the county. You maintain and operate one or more museums for housing and displaying historical materials. Also, you publish a historical magazine and other papers on historical subjects.

Your income is derived from membership dues, contributions, sale of publications, and investments.

Based on information supplied, and assuming your operations will be as stated in your exemption application, we have determined that you are exempt from Federal income tax under section 501(c)(3) of the Code. Any change in your purposes, character, or method of operation must be reported to the District Director, Baltimore, Maryland, which is your key district for exempt organization matters, so he may consider the effect of the change on your exempt status. You must also report any change in your name and address.

EIN - 54-6052638

APPROPRIATION
Virginia Land Conservation Fund
Moore's Creek Land Acquisition
\$175,000

WHEREAS, the City of Charlottesville, through Parks and Recreation, has been awarded funding from the Virginia Land Conservation Fund to acquire land along Moore's Creek

NOW, THEREFORE BE IT RESOLVED by the Council of the City of Charlottesville, Virginia, that the sum of \$175,000 is hereby appropriated in the following manner:

REVENUE

\$175,000 Fund: 426 WBS: PR-001 G/L Account: 430080

EXPENDITURES

\$175,000 Fund 426 WBS: PR-001 G/L Account: 599999

BE IT FURTHER RESOLVED, that this appropriation is conditioned upon the receipt of \$175,000 from the Virginia Land Conservation Fund.

Proposed acquisition of 8.6 acres of parkland property Moore's Creek near Azalea Park - 410 Old Lynchburg Road City of Charlottesville - VLCF 2022



Legend

- Parks
- Waterway
- Roads
- City Limit

**Total Proposed and Existing LWCF
Section 6(f)(3) protected area outlined in orange and red**

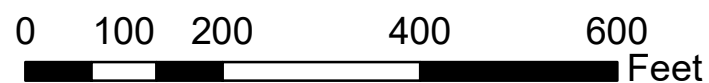

8.6 acres will be placed under section 6f protection if this property is funded with LWCF money.

SIGNED: _____ DATE: _____

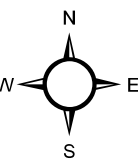

CITY OF CHARLOTTESVILLE, VIRGINIA
CITY COUNCIL AGENDA



Agenda Date:	March 20, 2023
Action Required:	Approve Resolution for second reading
Presenter:	Chris Gensic, Park and Trail Planner
Staff Contacts:	Chris Gensic, Park and Trail Planner
Title:	Appropriating funding from the Land and Water Conservation Fund for Moores Creek Parkland Acquisition - \$175,000 (1 of 2 readings)

Background

The City of Charlottesville, through Parks and Recreation, has been awarded funding from the federal Land and Water Conservation (LWCF) to assist with the acquisition of an 8.6 acre property along Moores Creek adjacent to Azalea Park. The property will be used for general park use, trail development, and to support urban agriculture and community gardens.

Discussion

This property is being funded with a matching grant from the Virginia Land Conservation Fund, so the purchase price is fully covered with grant funds. Local trail and land acquisition CIP funding has been used for the legal and appraisal work to date and will be used to record the deed. Acquisition will provide parks and recreation space as well as opportunities for stream and forest restoration work. Use of LWCF and VLCF funds will require the property to be placed in permanent open space public use status with deed language and easements. This property is located just across the city limit and is beneficial to the City as it eliminates the need for a bridge over Moores Creek to continue the Moores Creek Trail towards 5th Street, a bridge which would most likely cost more than the acquisition price of the property and would require regular maintenance.

Alignment with City Council's Vision and Strategic Plan

Acquisition of the property will further council goals of being a Green City by protecting the Moores Creek watershed and providing for urban forest and trail opportunities.

Community Engagement

The Bicycle, Pedestrian and Trail master plan and the Azalea Park Master Plans were developed through multiple public meetings and were approved by the City Council.

Budgetary Impact

Existing allocated CIP funds were used for legal and appraisal/title/survey fees.

Recommendation

Staff recommends appropriation of grant funds.

Alternatives

If grants funds are not appropriated, the property will not be purchased.

Attachments

1. City Council Resolution - LWCF Grant Appropriation - Moores Creek Land Acq

APPROPRIATION
Virginia Land Conservation Fund
Moore's Creek Land Acquisition
\$175,000

WHEREAS, the City of Charlottesville, through Parks and Recreation, has been awarded funding from the Virginia Land Conservation Fund to acquire land along Moore's Creek

NOW, THEREFORE BE IT RESOLVED by the Council of the City of Charlottesville, Virginia, that the sum of \$175,000 is hereby appropriated in the following manner:

REVENUE

\$175,000	Fund: 426	WBS: PR-001	G/L Account: 430080
-----------	-----------	-------------	---------------------

EXPENDITURES

\$175,000	Fund 426	WBS: PR-001	G/L Account: 599999
-----------	----------	-------------	---------------------

BE IT FURTHER RESOLVED, that this appropriation is conditioned upon the receipt of \$175,000 from the Virginia Land Conservation Fund.

CITY OF CHARLOTTESVILLE, VIRGINIA
CITY COUNCIL AGENDA



Agenda Date:	March 20, 2023
Action Required:	No Council Action Required
Presenter:	Lauren Hildebrand, Director of Utilities
Staff Contacts:	Lauren Hildebrand, Director of Utilities
Title:	Land Use and Environmental Planning Committee Semi-Annual Report (written report only)

Background

In 1986, the Planning and Coordination Council (PACC) was established with the purpose of promoting cooperation in planning and community development among the City of Charlottesville, Albemarle County and the University of Virginia (UVA). As an advisory body, PACC fostered cooperative planning and provided guidance and recommendations for decisions made by the City, the County and UVA.

In November 2019, City Council, Albemarle County Board of Supervisors and UVA approved dissolution of the PACC and established the Land Use and Environmental Planning Committee (LUEPC) in order to broaden PACC's collaboration beyond land use and to include environmental topics and sustainability. Also, LUEPC would allow professional staff to develop solutions on a continuous basis with regularly scheduled reports to leadership of all three entities. LUEPC is intended to be a vehicle to collaborate and coordinate land use and development plans and projects and to consider environmental and infrastructure issues facing the community.

Discussion

LUEPC met virtually for the second half of 2022. The committee has continued concentrating on project discussion and coordination. The agendas for the monthly meeting are developed around themes – either geographical areas or specific topics. LUEPC's Semi-Annual Report for the second half of 2022 (attached) has been compiled and includes the highlights of the meetings.

Alignment with City Council's Vision and Strategic Plan

This contributes to Goal 3 of the Strategic Plan: A Beautiful and Sustainable Natural and Built Environment.

Community Engagement

The agenda and meeting minutes for the LUEPC's meetings are published on the Thomas Jefferson Planning District Commission's website for the community to review.

Budgetary Impact

There are no budget impacts.

Recommendation

There are no staff recommendations and the report is intended to inform City Council of the LUEPC meetings.

Alternatives**Attachments**

1. LUEPC Semi-Annual Report - JUL thru DEC 2022



Land Use and Environmental Planning Committee
Second Half Yearly Report
July through December 2022 Update

The Land Use and Environmental Planning Committee (LUEPC) was established to replace the Planning and Coordination Council (PACC) by the County of Albemarle, the City of Charlottesville, and the University of Virginia in 2019. The Committee is intended as a vehicle to share and coordinate land use and development plans and projects; consider environmental and infrastructure issues facing the community; and, from time to time, advance ideas and solutions that support the mutual advantage of these entities. As part of its charge, the Committee shall, not less than twice each year, submit a report summarizing the group's work.

The County, City and the University face similar environmental planning and project challenges. The committee, by its nature, creates opportunities to address these shared challenges by coordinating community messaging and institutional practices. The second half of 2022 has focused on project discussions and coordination. The agendas for the monthly meeting are formed around themes - either geographical areas or specific topics. This report will focus on some of the key themes under discussion. The Committee's meeting agendas, minutes and presentations are posted on the LUEPC website which is hosted by the Thomas Jefferson Planning District Commission (TJPDC): <https://vapacc.org/>.

Charge Statement

The Land Use and Environmental Planning Committee is established as a vehicle to share and coordinate land use and development plans and projects; consider environmental and infrastructure issues facing the community; and, from time to time, advance ideas and solutions that support our mutual advantage. The LUEPC may also serve as an advisory committee to the City, County, and UVA. The Committee will meet regularly to discuss timely issues from each entity and share that information with the public and each entity's senior leadership at biannual updates of all three entities. Through its work, the Committee further seeks to ensure that the actions, policies, and processes of the Committee are reflective of an ongoing commitment by the entities to support an equitable and inclusive community. The Committee defines equity as all community members having access to community benefits and opportunities needed to reach their full potential and to experience optimal well-being and quality of life; inclusion means that all peoples shall be respected and valued as members of this community. The Three-Party Agreement dated May 5, 1986, remains in effect as to land use planning between the City, County and UVA.



Land Use and Environmental Planning Committee
PRELIMINARY - Second Half Yearly Report – July through December 2022
(Virtual Meetings due to COVID-19)

September 16, 2022:

CITY OF CHARLOTTESVILLE
Presenter: Brennan Duncan, Traffic Engineer
• 5th Street Update
Link: [CITY 5th STREET UPDATE](#)

ALBEMARLE COUNTY
Presenter: Kevin McDermott, Community Development Planning Manager
• 5th Street Update & Latest News on the Hydraulic/29 project with VDOT
Link: [COUNTY 5TH STREET UPDATE & LATEST NEWS ON THE HYDRAULIC/29 PROJECT WITH VDOT](#)

ALBEMARLE COUNTY
Presenter: David Benish, Development Process Manager
• Rio Road Corridor Plan
Link: [RIO ROAD CORRIDOR PLAN](#)

October 21, 2022:

CITY OF CHARLOTTESVILLE
Presenters: Susan Elliott, Climate Planning Consultant
• Climate Vulnerability Risk Assessment/Flood Resilience
Link: [City Climate Vulnerability Risk](#)

CITY OF CHARLOTTESVILLE
Presenters: Andrea Henry, PE
• Climate Vulnerability Risk Assessment/Flood Resilience
Link: [City Flood Resilience Planning](#)

ALBEMARLE COUNTY
Presenter: Gabe Dayley, Climate Protection Program Manager
• Climate Risk Assessment
Link: [County Climate Risk Assessment](#)

RIVANNA WATER & SEWER AUTHORITY
Presenter: Bill Mawyer, Executive Director
• RWSA Sustainability Initiatives
Link: [RWSA Sustainability Initiatives](#)



December 16, 2022:

UNIVERSITY OF VIRGINIA

Presenter: Michael Joy, Associate University Architect

- Athletics Complex

Link: [Athletics Complex](#)

UNIVERSITY OF VIRGINIA

Presenter: Alice J. Raucher, Architect for the University

- Karsh Institute of Democracy

Link: [Karsh Institute of Democracy](#)

ALBEMARLE COUNTY

Presenter: Jodie Filardo, Community Development Director

- Old Ivy Road-Transportation Summary

Link: [Old Ivy Road-Transportation Summary](#)

LUEPC Membership

City of Charlottesville

Neighborhood Development Services Director

Director of Public Works

Director of Utilities

Representative from the City Planning Commission

Albemarle County

Community Development Director

Facilities and Environmental Services Director

Representative from the County Planning Commission

University of Virginia

Architect for the University

Director of Facilities Management

Operations Director of Real Estate and Leasing Services

University of Virginia Foundation

Director of Design and Development

Director of Real Estate Asset Management

Rivanna Water and Sewer Authority

Executive Director

